

MASTERFLEX® B/T MFLX77112-10

OPERATING MANUAL:

**SS B/T WASHDOWN
DIGITAL PUMP DRIVES
WITH ADVANCED
CONNECTIVITY**

Model No.

MFLX77112-10

© 2023 Masterflex LLC. All rights reserved.

Masterflex® is a registered trademark of MasterflexLL C.

Trademarks bearing the ® symbol in this publication are registered in the US and in other countries.

PUMP FOR LIQUIDS ORIGINAL INSTRUCTIONS

Table of Contents

SECTION 1: INTRODUCTION.....	1-1
Safe Operation.....	1-1
About the B/T.....	1-2
Package Contents.....	1-2
FEATURES	1-2
SECTION 2: BASIC SETUP & SETTINGS.....	2-1
Touchscreen Icons.....	2-2
Before Starting the Drive.....	2-3
Switching on the Drive.....	2-3
Settings.....	2-4
Language Settings.....	2-4
Setting the Time.....	2-4
Setting the Date.....	2-5
Display Brightness.....	2-5
Dispense Completion Alerts.....	2-5
Batch Completion Alerts.....	2-5
Analog Output.....	2-5
Device Information.....	2-6
Screen Saver.....	2-6
Device Name.....	2-6
WI-FI Settings.....	2-7
Ethernet Settings.....	2-7
User Management.....	2-8
Auto Start.....	2-9
Loading Tubing.....	2-10
Step 1.....	2-10
Step 2.....	2-10
Step 3.....	2-11
Step 4.....	2-11
Priming the Pump Drive.....	2-12
Tube Calibration	2-13
Tube Calibration Screen.....	2-13
SECTION 3: OPERATION.....	3-1
Mode Selection Screen.....	3-1
Continuous Mode.....	3-2
Continuous Mode Run Screen.....	3-2
Continuous Mode Operation.....	3-3
Saving Continuous Mode Settings as a New Program.....	3-4
Time Mode.....	3-5

Time Mode Run Screen.....	3-5
Time Mode Edit Screen.....	3-6
Time Mode Operation.....	3-6
Saving Time Mode Settings as a New Program.....	3-8
Volume Mode.....	3-9
Volume Mode Run Screen.....	3-9
Volume Mode Edit Screen.....	3-10
Volume Dispense Mode Operation.....	3-10
Saving Volume Mode Settings as a New Program.....	3-12
Volume Record.....	3-12
Analog Input Mode.....	3-14
Analog Input Mode Run Screen.....	3-14
Analog Input.....	3-15
Saving Analog Input Mode Settings as a New Program.....	3-16
MasterflexLive™.....	3-17
Custom Program Modes.....	3-17
Adding a New Program: Continuous Mode.....	3-17
Adding a New Program: Time Mode.....	3-17
Adding a New Program: Volume Mode.....	3-19
Adding a New Program: Analog Input Mode.....	3-20
Using Program Modes.....	3-21
Editing a Program.....	3-21
Deleting a Program.....	3-22
SECTION 4: COMMUNICATION SPECIFICATION.....	4-1
Ethernet/IP Mode.....	4-1
Ethernet/IP Setup.....	4-1
Masterflex Ethernet/IP.....	4-4
Profibus.....	4-6
Profibus Mode.....	4-6
Profibus Setup.....	4-6
Profibus Settings.....	4-6
Profibus data.....	4-8
SECTION 5: SERVICE & MAINTENANCE.....	5-1
Firmware Updates.....	5-1
Restore Factory Settings.....	5-1
Cleaning the Pump Drive.....	5-2
Accessories.....	5-2
B/T Accessories.....	5-2
Replacement Parts.....	5-2
Replacing Rollers.....	5-3
Tubing Types.....	5-4
31-Pin Electrical Connections.....	5-5
Troubleshooting.....	5-6





Error Definitions.....	5-7
Specifications.....	5-8
Technical Assistance.....	5-10
Product Return.....	5-10
Warranty.....	5-10
Disposal	5-10

SECTION 1: INTRODUCTION







SAFE OPERATION

The SS B/T Washdown Digital Pump Drive with Advanced Connectivity is designed for pumping and dispensing applications in laboratory and process environments. Confirm that the pump drive is operated only in the manner specified in this operating manual and that safe work practices and Good Laboratory Practice (GLP) are followed. Misuse of the pump drive may compromise built-in safety protections and result in injury and/or damage to equipment. Do not operate the pump drive with water on the surface of the touchscreen.

The following Safety Symbols are used in this documentation:

	CAUTION: Risk of Danger. Consult Operating Manual for nature of hazard and corrective actions.
	CAUTION: Risk of crushing. Keep fingers away from the rotor while the pump is in operation. Stop pump before loading or unloading tubing.
	CAUTION: Hot Surface. Do not touch.
	CAUTION: Risk of electric shock. Consult Operating Manual for nature of hazard and corrective actions.

Please observe the following cautions and recommendations:

	CAUTION: Do not operate the pump in a way that exceeds the designed operating and environmental conditions outlined in this operating manual.
	CAUTION: The pump must not be used: <ul style="list-style-type: none"> • As a medical device. • In explosion proof chambers or in the presence of flammable gases or fumes.
	CAUTION: The circuit between the mains power supply and the pump must be connected to earth ground.
	CAUTION: Turn the drive off before removing or installing tubing. Fingers or loose clothing could get caught in the drive mechanism.
	CAUTION: Do not open or remove the housing while the pump is operating.
	CAUTION: Tubing can tear and burst during operation. It is the responsibility of the customer to take the necessary precautions to avoid injury or damage to equipment.
	CAUTION: It is recommended that any repairs be performed only by an authorized technician. If service and repairs are performed by the customer or by any third party company, Masterflex denies all responsibility.

ABOUT THE B/T

The SS B/T Washdown Digital Pump drive with advanced connectivity offers precise flow control and highly accurate fluid dispensing ideal for pumping high viscous and shear-sensitive liquids. These pumps are also ideally suited for use where sterile conditions and purity are required. Toxic and hazardous fluids can be pumped with the proper selection of MASTERFLEX PERFECTPOSITION B/T tubing since the fluid contacts only the tubing and not the pump. All B/T precision drives include a highly accurate, maintenance-free motor and an easy to navigate touchscreen that makes setup and operation easier than ever. The B/T range features Ethernet and Wi-Fi connections for web-based monitoring using the MasterflexLive website (see www.masterflex.com), and remote analog input control and monitoring through the pump drive's 31-Pin female connection port

Package Contents

NOTE: Please check the package and its contents for any visible signs of damage. If any damage is found please contact Technical Assistance immediately (see "[Technical Assistance](#)" on page 5-10).

- Pump Drive
- Power Cable
- Quick Start Guide
- Flash Drive Containing the Operating Manual

FEATURES

- A 5-inch multi-language touchscreen display providing easy access to user-defined operation parameters and direct readouts of pump operation data, including pump speed, flow rates, flow direction, and batch totals.
- Volume, Time, Continuous, and Analog Input modes for quick and easy operation.
- User selectable dispense volumes, tube diameters, flow rates, pump speeds, and run times.
- Easy user management with three levels of access: ADMIN, SUPER USER and USER.
- Wi-Fi and Ethernet connectivity.
- Brushless, maintenance-free motor offering $\pm 0.1\%$ speed control accuracy with a turndown ratio greater than 32:1.
- Easy pump priming and tube calibration.
- B/T models have a maximum speed of 321 RPM and flow rate capacities that range from 1.3 L/min through to 42 L/min (depending on the model and tubing size selected).



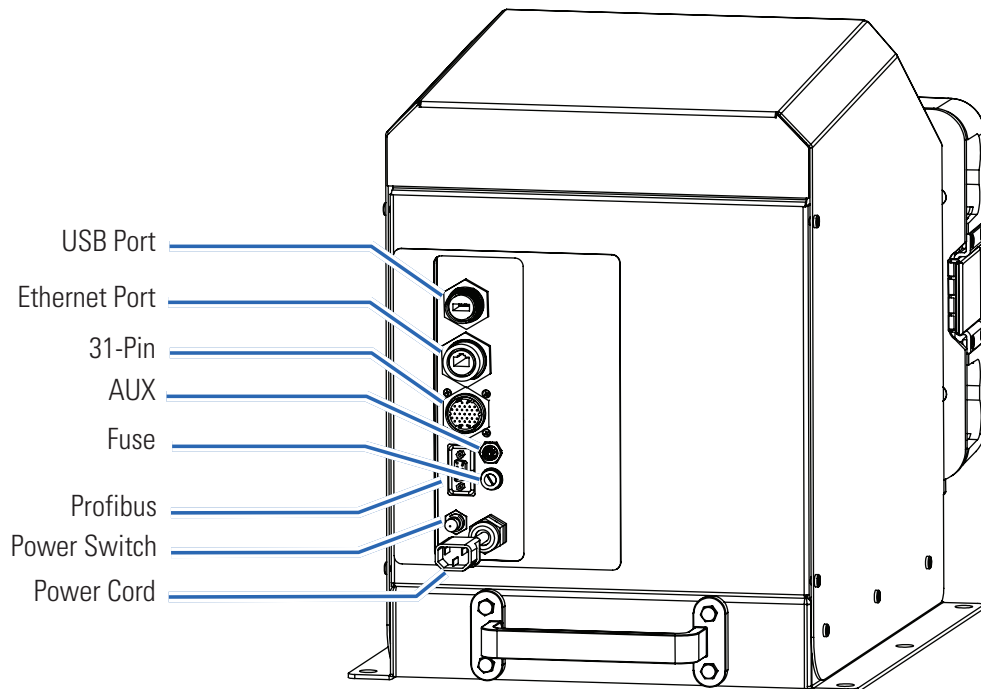
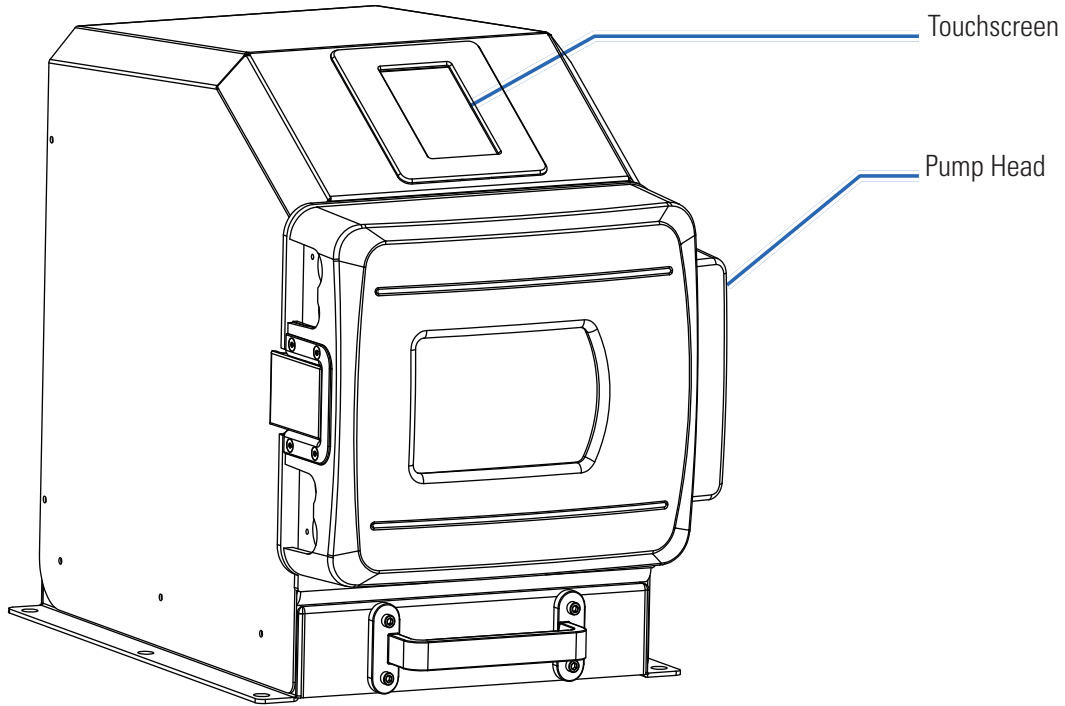

SECTION 2: BASIC SETUP & SETTINGS



TOUCHSCREEN ICONS

	Analog Input Mode		New User
	Calibrate		Pause
	Calibration Complete		Prime
	Clockwise		Program
	Close/Cancel		Ramp Down
	Confirm		Ramp Up
	Connectivity Status		Record Volume
	Continuous Mode		Reset
	Counterclockwise		Screen Lock
	Delete		Settings
	Display Brightness		Start
	Edit		Stop
	Language		Time Mode
	Logout		Update Available
	New Program		Volume Mode

BEFORE STARTING THE DRIVE

	CAUTION: Do not block the rear panel of the pump drive. The power switch must always be easy to access and the power cord must always be easy to disconnect.
	CAUTION: Turn the drive off before removing or installing tubing. Fingers or loose clothing could get caught in the drive mechanism.
	CAUTION: The power cord set supplied with your pump drive meets the requirements of the country where you purchased the pump drive. If you use the pump drive in another country, you must use a power cord set that meets the requirements of that country.
	CAUTION: To avoid electrical shock, the power cord protective grounding conductor must be connected to ground. Not for operation in wet locations as defined by EN61010-1.

- Ensure the pump drive is mounted on a flat surface.
- Ensure adequate air flow around the pump drive and ensure that the ambient air temperature does not exceed 104° F (40° C).
- Tubing should be clean and routed so that bend radii are at a minimum of four (4) times the outside tube diameter and are as short as possible.
- Use the appropriate tube diameter for the required flow rate and viscosity.
- Recalibrate tubing regularly to maintain the best flow rate accuracy (for further information see "[Tube Calibration](#)" on page 2-12).
- For tubing selection and compatibility go to www.masterflex.com.
- Unplug the pump drive's power cable from the mains power outlet when cleaning or performing maintenance on the drive.

SWITCHING ON THE DRIVE

1. Plug in and securely fasten the supplied power cable located at the rear of the drive.
2. Plug the opposite end of the power cable into a mains power outlet.
3. Switch the drive on using the power switch located at the rear of the drive. **NOTE:** The drive takes approximately two minutes to complete start-up.

NOTE:

- On the initial start-up the Language Settings Screen will be displayed. A language must be selected before pump operation (for further information see "[Language Settings](#)" on page 2-4).
- If User Management is enabled you may be prompted for a username and password (for further information see "[User Management](#)" on page 2-8).
- Following the initial start-up all subsequent start-ups will revert to the mode of operation screen previously in use.
- After 30 minutes of inactivity the B/T will enter sleep mode and the display will turn off. Tapping the touchscreen will reactivate the drive. To enable (default) or disable the screen saver see "[Screen Saver](#)" on page 2-6.

SETTINGS

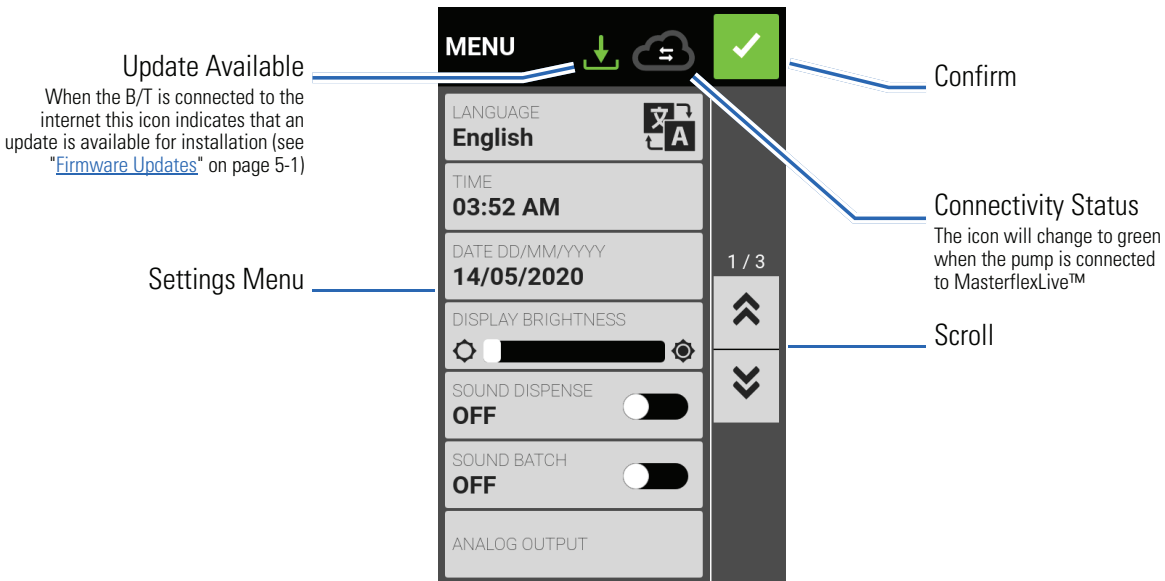

The Settings Screen allows access to basic configuration settings. The Settings Screen is accessed by tapping **SETTINGS**  from any of the mode screens. **NOTE:** If User Management is enabled only users with authorization can access the Settings Screen (for further information see "[User Management](#)" on page 2-8).



Language Settings

The B/T Digital Pump Drive can display Chinese, English, French, German, Italian, Japanese, and Spanish languages. The default display language is English.

To change the display language:

1. Tap **SETTINGS**  from any of the mode screens. The Settings Screen will be displayed.
2. Tap **LANGUAGE**.
3. Select the desired language from the available list.
4. Tap **CONFIRM**  to save the new language selection.

Setting the Time



To change the time:

1. Tap **SETTINGS**  from any of the mode screens. The Settings Screen will be displayed.
2. Tap **TIME**.
3. Select either 12-HOUR or 24-HOUR time.
4. Tap **HH** to select hours and enter the desired time using the onscreen keypad.
5. Tap **MM** to select minutes and enter the desired time using the onscreen keypad.
6. If using 12-HOUR time, tap **AM/PM** to select either AM or PM.

7. Tap CONFIRM  to save or CANCEL  to discard changes.

Setting the Date

To change the date:

1. Tap SETTINGS  from any of the mode screens. The Settings Screen will be displayed.
2. Tap DATE.
3. Select the desired date format (either month/day/year or day/month/year).
4. Tap the desired MONTH, DAY or YEAR field to select and then enter the date using the onscreen keypad.
5. Tap CONFIRM  to save or CANCEL  to discard changes.

Display Brightness

To adjust the display brightness:

1. Tap SETTINGS  from any of the mode screens. The Settings Screen will be displayed.
2. Use the DISPLAY BRIGHTNESS slider to adjust the touchscreen brightness to the desired level.

Dispense Completion Alerts

When Sound Dispense is enabled a short beep will sound at the completion of each pump dispense.

To enable or disable the dispense completion alert:

1. Tap SETTINGS  from any of the mode screens. The Settings Screen will be displayed.
2. Tap the SOUND DISPENSE toggle to select either ON or OFF.

Batch Completion Alerts





When Sound Batch is enabled a single long beep will sound at the completion of each batch cycle.

To enable or disable the batch cycle completion alert:

1. Tap SETTINGS  from any of the mode screens. The Settings Screen will be displayed.
2. Tap the SOUND BATCH toggle to select either ON or OFF.

Analog Output

The B/T supports and controls analog output through the pump drive's 31-pin connection (for further information see "[31-Pin Electrical Connections](#)" on page 4-5).

1. Tap SETTINGS  from any of the mode screens. The Settings Screen will be displayed.
2. Tap ANALOG OUTPUT. The Analog Output Screen will be displayed.
3. Tap to select the desired analog output type from the available list.
4. If using either ANALOG: VOLTAGE or ANALOG: CURRENT:
 - a. Tap EDIT . The Analog: Voltage Edit Screen or Analog: Current Edit Screen will be displayed.
 - b. Select the desired current or voltage operating range from the available list.
 - c. Tap CONFIRM  to save or CANCEL  to discard changes. The Analog Output Screen will be



displayed.

5. Tap CONFIRM  .

Device Information

The Device Information Screen provides pump drive details such as MAC address, IP address, software version, build date, and firmware version. Factory reset and updates are also accessed from the Device Information Screen.

To access the Device Information Screen:



1. Tap SETTINGS  from any of the mode screens. The Settings Screen will be displayed.
2. SCROLL  through the Settings Screen pages to locate DEVICE INFORMATION.
3. Tap DEVICE INFORMATION. The Device Information Screen will be displayed.

See also "[Firmware Updates](#)" on page 5-1, and "[Restore Factory Settings](#)" on page 5-1.

Screen Saver

The B/T has a screen saver to help extend the display life of the touchscreen. After 30 minutes of inactivity the B/T will enter sleep mode and the display will turn off. Tapping the touchscreen will reactivate the drive.





To enable or disable the screen saver:

1. Tap SETTINGS  from any of the mode screens. The Settings Screen will be displayed.
2. SCROLL  through the Settings Screen pages to locate SCREEN SAVER.
3. Tap the SCREEN SAVER toggle to select either ON or OFF.

Device Name

Individual names can be assigned to each B/T Digital Pump Drive to make identification easier when using more than one pump.

To assign a pump drive name:

1. Tap SETTINGS  from any of the mode screens. The Settings Screen will be displayed.
2. SCROLL  through the Settings Screen pages to locate DEVICE NAME.
3. Tap DEVICE NAME. The Device Name Screen will be displayed.
4. Enter the desired pump name using the onscreen keypad (up to 8 characters).
5. Tap CONFIRM  to save or CANCEL  to discard changes.



Wi-Fi Settings

The B/T can connect to a network using Wi-Fi and Ethernet connections.





NOTE:

- The Ethernet connection will take priority if both Wi-Fi and Ethernet are used simultaneously.
- The B/T supports WEP, WPA, WPA2, and None (open) Wi-Fi security protocols.

To select a Wi-Fi network:

1. Tap **SETTINGS**  from any of the mode screens. The Settings Screen will be displayed.
2. **SCROLL**  through the Settings Screen pages to locate **WIFI SETTINGS**.
3. Tap **WIFI SETTINGS**. The Wi-Fi Settings Screen will be displayed.
4. If required, tap the **WIFI** toggle to select either **ON** or **OFF**.
5. Tap the desired Wi-Fi network from the available list.
6. If required, enter the network **PASSWORD** using the onscreen keypad.
7. Tap **CONNECT** to join the network or **CANCEL** to cancel.
8. Tap **CONFIRM**  to return to the Settings Screen.

To remove a Wi-Fi network:

1. Tap **SETTINGS**  from any of the mode screens. The Settings Screen will be displayed.
2. **SCROLL**  through the Settings Screen pages to locate **WIFI SETTINGS**.
3. Tap **WIFI SETTINGS**. The **WIFI** Settings Screen will be displayed.
4. Locate the desired Wi-Fi network and tap **REMOVE WIFI** .
5. Tap **REMOVE** to remove the network or **CANCEL** to discard changes.
6. Tap **CONFIRM**  to return to the Settings Screen.





Ethernet Settings

The B/T can connect to a network using Wi-Fi and Ethernet connections.

NOTE:

- Confirm that the Ethernet cable is securely attached to the Ethernet port at the rear of the pump drive.
- The Ethernet connection will take priority if both Wi-Fi and Ethernet are used simultaneously.

To configure Ethernet settings:

1. Tap **SETTINGS**  from any of the mode screens. The Settings Screen will be displayed.
2. **SCROLL**  through the Settings Screen pages to locate **ETHERNET SETTINGS**.
3. Tap **ETHERNET SETTINGS**. The Ethernet Settings Screen will be displayed.
4. Tap **DHCP** to automatically configure IP settings or **STATIC** to manually edit settings using the onscreen keypad.
5. Tap **CONFIRM**  to save or **CANCEL**  to discard changes.

User Management

The B/T allows user access to be controlled using configurable permission levels.

Default permissions:

- USER: Able to use basic pump drive functions and run programs.
- SUPER USER: Same level of access as USER but with the ability to create and modify programs.
- ADMIN: Full administrative access to the drive.

User and Super User permission levels can be configured to allow access to different Settings Menu items.

Default ADMIN username and password:





When switching on User Management for the first time, or following a factory reset, you will be prompted for a username and password. You must log in using the below default ADMIN user account details to access user management settings.

Default username: **admin**





Default password: **123456**

It is recommended that the default password be changed after logging in (see **Editing an existing user** below for information on changing user passwords).

Configuring user level permissions:



1. Tap **SETTINGS**  from any of the mode screens. The Settings Screen will be displayed.
2. **SCROLL**  through the Settings Screen pages to locate **USER MANAGEMENT**.
3. If required, tap the **USER MANAGEMENT** toggle to select **ON**.
4. Tap **MODIFY USER**.
5. Tap **ACCESS LEVELS**.
6. Tap **USER** or **SUPERUSER**.
7. Select the desired settings menu items to be included in the user level.
8. Tap **CONFIRM**  to save or **CANCEL**  to discard any changes.

Adding a new user:





1. Tap **SETTINGS**  from any of the mode screens. The Settings Screen will be displayed.
2. **SCROLL**  through the Settings Screen pages to locate **USER MANAGEMENT**.
3. If required, tap the **USER MANAGEMENT** toggle to select **ON**.
4. Tap **MODIFY USER**.
5. Tap **NEW USER** .
6. Tap **USERNAME** and enter the new username using the onscreen keypad.
7. Tap **PASSWORD** and enter the desired password using the onscreen keypad. **NOTE:** The password must be at least six characters long.
8. Tap the required **PERMISSION LEVEL**. **NOTE:** There must always be at least one ADMIN user.
9. Tap **CONFIRM**  to save or **CANCEL**  to discard any changes.

Deleting a user:

NOTE: There must always be at least one ADMIN user. ADMIN users cannot delete their own user profile.

1. Tap SETTINGS  from any of the mode screens. The Settings Screen will be displayed.
2. SCROLL  through the Settings Screen pages to locate USER MANAGEMENT.
3. Tap MODIFY USER.
4. Locate the desired username from the available list and then tap the DELETE USER  icon located next to the username.
5. Tap DELETE to delete user or CANCEL to cancel.



Editing an existing user:

1. Tap SETTINGS  from any of the mode screens. The Settings Screen will be displayed.
2. SCROLL  through the Settings Screen pages to locate USER MANAGEMENT.
3. Tap MODIFY USER.
4. Select the desired username.
5. Edit as required.
6. Tap CONFIRM  to save or CANCEL  to discard any changes.

Auto Start

The B/T has an auto start that will resume pump operation when power is restored after a power outage.

To enable auto start:

1. Tap SETTINGS  from any of the mode screens. The Settings Screen will be displayed.
2. SCROLL  through the Settings Screen pages to locate AUTO START.
3. Tap the AUTO START toggle to select either ON or OFF.

LOADING TUBING



CAUTION: Turn the drive off before removing or installing tubing. Fingers or loose clothing could get caught in the drive mechanism.

Use Masterflex *PERFECTPOSITION* B/T Tubing. These pumps are designed to use *PERFECTPOSITION* B/T tubing sizes 87 and 91 only. The *PERFECTPOSITION* tubing retention marks (found on most of the tubing formulations), indicate the best placement of the tubing within the pump head.

NOTE: The tubing sizes refer to the last two digits of the Masterflex *PERFECTPOSITION* B/T tubing model numbers.

NOTE:

- Check to confirm that the rollers are clean and free of defects.
- Tubing should be clean and routed so that the bend radii are at a minimum of four (4) times the outside tube diameter and are as short as possible.
- Use the appropriate tube diameter for the required flow rate and viscosity.
- Recalibrate tubing regularly to maintain the best flow rate accuracy (for further information see "[Tube Calibration](#)" on page 2-13).
- After installing new tubing the pump should be run for 20-30 minutes to properly condition the tubing and increase dispense accuracy (for further information see "**To condition new tubing**" below). **To condition new tubing:**

STEP 1



Step 1: Unlatch the door, but first cut off the power to the pump by disconnecting the line cord. Do not assume that turning off the switch is "safe enough".

STEP 2



Step 2: Insert the tube in the appropriate upper tube retaining pocket. Line up the Perfectposition placement marks printed on the tube with outside edge of the retainer assembly.

STEP 3



Step 3: Going with the natural lay or curvature of the tubing, wrap the tubing around the assembly and insert the tubing in the lower retaining pocket.

STEP 4



Step 4: Close the door and insure that door latch is engaged and locked.

After installing new tubing the pump should be run for 20-30 minutes at full rpm (321 rpm). This is recommended to properly condition new tubing and to increase dispense accuracy. If required, the pump can be run dry while conditioning.

1. Switch the drive on using the power switch located at the rear of the drive. **NOTE:** If User Management is enabled you may be prompted for a username and password (For further information see "[User Management](#)" on page 2-8).
2. Tap CONTINUOUS from the Mode Selection Screen. The Continuous Mode Run Screen will be displayed.
3. Select the flow rate and flow units:
 - a. Tap FLOW RATE. The Flow Rate Screen will be displayed.
 - b. Tap UNITS. The Flow Units Screen will be displayed.
 - c. Tap RPM.
 - d. Tap CONFIRM to return to the Flow Rate Screen.
 - e. Tap FLOW RATE to select field and then enter 321 using the onscreen keypad.
 - f. Tap CONFIRM to save and return to the Continuous Mode Screen.
4. Tap START . The drive will commence operation.
5. Allow the pump to run for 20-30 minutes before tapping STOP . The tube is now conditioned and ready for priming, calibration, and use.

NOTE:

- Once the tube has been loaded and conditioned the new tube size will need to be selected from the Tube Size Screen. The Tube Size Screen can be accessed from the Continuous Mode Run Screen or from either of the Volume or Time Mode Edit screens.

- It is recommended that you calibrate new tubes to ensure accurate flow rate and fluid dispensing (for further information see "[Tube Calibration](#)" on page 2-13).
- When using new tubing it is possible that the pump will not prime and/or will not dispense fluid (depending on the type of tubing used). If this occurs, it is recommended that you wet the tubing and then run the pump with the tubing for approximately 20-30 minutes.

PRIMING THE PUMP DRIVE

It is recommended that you prime the pump drive before use. Priming the pump draws fluid through the tubing and eliminates air pockets from the system.



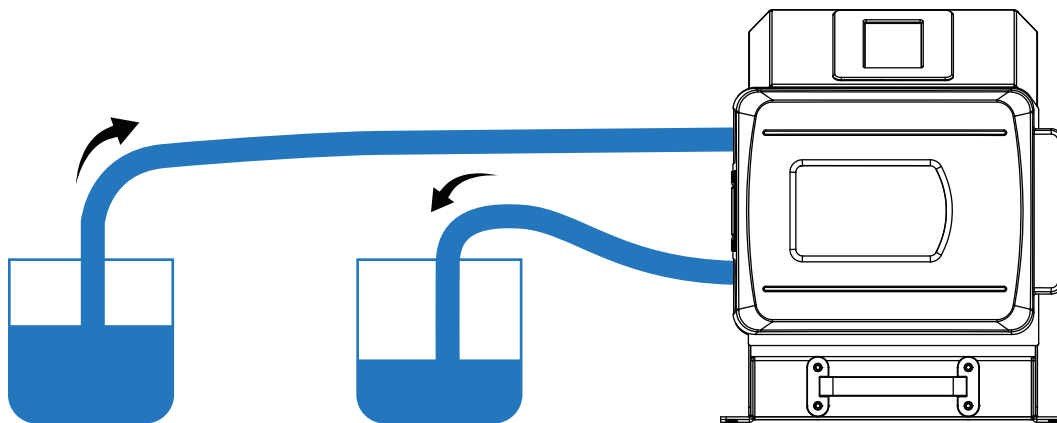

CAUTION: Turn the drive off before removing or installing tubing. Fingers or loose clothing could get caught in the drive mechanism.

Example Flow System



To prime the pump drive:

1. Insert the tubing into the pump head (for further information see "[Loading Tubing](#)" on page 2-10).
2. Insert the tube inlet into the supply fluid.
3. Insert the tube outlet into an appropriate container.
4. Switch the drive on using the power switch located at the rear of the drive. **NOTE:** If User Management is enabled you may be prompted for a username and password (For further information see "[User Management](#)" on page 2-8).
5. Navigate to the Continuous, Time or Volume Mode screens.
6. Press and hold PRIME  until there are no bubbles visible in the tubing. Priming will stop when PRIME  is released.

TUBE CALIBRATION

To ensure accurate dispensing of fluids, tube calibration should be performed whenever fluids, flow rate or tubing is changed. Tube calibration can be accessed from the Continuous Mode Run Screen or from either of the Volume or Time Mode Edit screens.



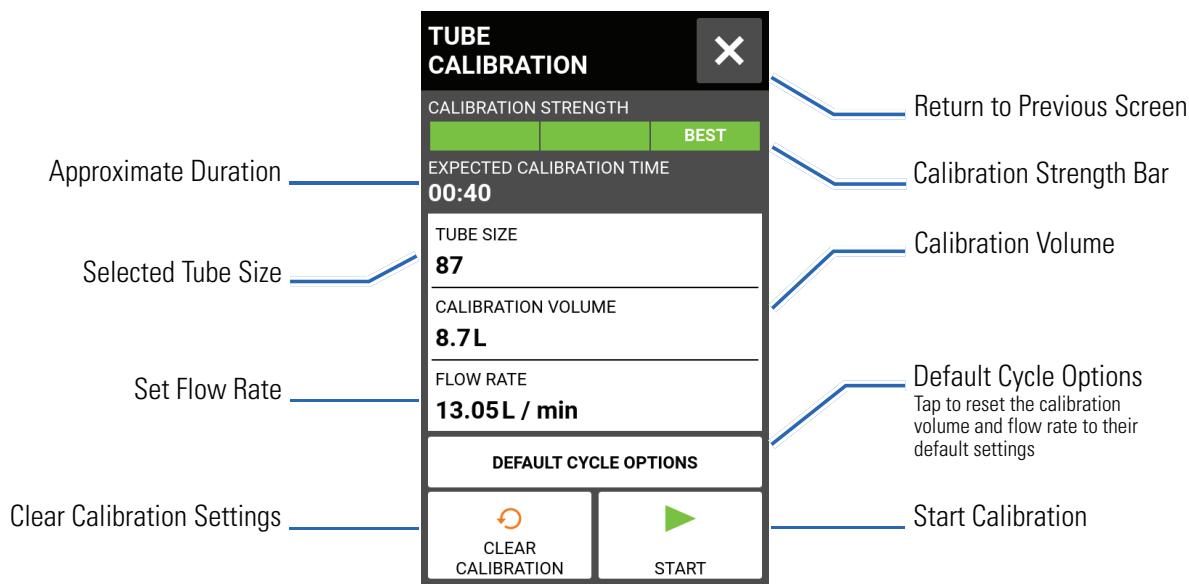

Tube Calibration Screen













General Preparation:

- Confirm the correct tubing has been selected and is properly loaded into the pump drive (for further information see "[Loading Tubing](#)" on page 2-10).
- Confirm all fluids and containers are ready.

To calibrate tubing:





1. Insert the tube inlet into the supply fluid.
2. Insert the tube outlet into a suitable container. **NOTE:** The container should be placed on a scale for increased accuracy. If using a scale, an acceptable weight to volume conversion for water is: 1 kg = 1 L.
3. Switch the drive on using the power switch located at the rear of the drive. **NOTE:** If User Management is enabled you may be prompted for a username and password (For further information see "[User Management](#)" on page 2-8).
4. Navigate to the Continuous, Time or Volume Mode screens.
5. Tap DIRECTION to select either clockwise  or counterclockwise  flow direction.
6. If required, Tap START  and allow the pump to run for approximately 20-30 minutes. This step is recommended to properly condition new tubing and to increase calibration accuracy. **NOTE:** If required, the pump can be run dry while conditioning the tube.
7. Press and hold PRIME  to prime the pump. Priming will stop when PRIME  is released.

8. Tap SIZE from the Continuous Mode Screen or tap EDIT  and then SIZE if either the Volume or Time Mode Screen is displayed. The Tube Size Screen will be displayed.
 - a. Select the desired tube size from the list of available options.
 - b. Tap CONFIRM  to save or CANCEL  to discard changes and return to previous screen.
9. Tap CALIBRATE . The Tube Calibration Screen will be displayed.
10. Tap CALIBRATION VOLUME. The Calibration Volume Screen will be displayed.
 - a. Enter the desired calibration volume using the onscreen keypad. **NOTE:** The default volume or greater will ensure the best calibration.
 - b. Tap CONFIRM  to save or CANCEL  to discard changes and return to the previous screen.
11. Tap FLOW RATE. The Calibration Flow Rate Screen will be displayed.
 - a. Enter the desired flow rate using the onscreen keypad.
 - b. Tap CONFIRM  to save or CANCEL  to discard changes and return to the previous screen. **NOTE:** The drive will adjust the displayed flow rate after calibration is complete.
12. Tap START  to begin calibration. **NOTE:** Calibration progress will be displayed on the touchscreen.
13. When calibration is complete use the onscreen keypad to enter the measured volume of fluid from the tube outlet container.
14. Tap CONFIRM  to complete calibration and return to the previous mode screen. Calibration Complete  should now be displayed to indicate that calibration has been completed for the current tube size, tube volume, and flow rate.

NOTE:

- The estimated accuracy for the selected calibration settings is shown in the Calibration Strength Bar on the Tube Calibration Screen. Calibration accuracy can be improved by using a larger calibration volume and/or altering the flow rate.
- Calibration settings are retained and transferred to other mode screens when entering or leaving the Tube Calibration Screen.
- If the drive is stopped during calibration the calibration will be discarded and the previous mode screen will be displayed. Empty the container before restarting the procedure.
- Calibration time at the maximum allowable flow rate (default max flow rate) is approximately 10 seconds. Calibration time at the minimum allowable flow rate (approximately 4% of the maximum flow rate) is 4 minutes.
- Minimum and maximum flow rates will change after calibration due to a recalculation of the volume of fluid per pump revolution.
- The best results are obtained after tubing has been run in the pump for approximately 20-30 minutes.
- Steps 9–14 can be repeated as necessary to optimize the accuracy of the tubing calibration.

SECTION 3: OPERATION

	WARNING: Tube breakage may result in fluid being sprayed from the pump. Use appropriate measures to protect operator and equipment.
	CAUTION: Keep fingers away from the rotor while the pump is in operation. Stop the pump before loading or unloading tubing.
	CAUTION: Hot Surface. Do not touch.
	CAUTION: To avoid electrical shock, the power cord protective grounding conductor must be connected to ground. Not for operation in wet locations as defined by EN61010-1.

MODE SELECTION SCREEN

The Mode Selection Screen allows access to the drive’s four basic operation modes (CONTINUOUS, TIME, VOLUME, and ANALOG INPUT) as well as the New Program Screen and user defined programs. The Mode Selection Screen can be accessed from any of the mode screens by tapping the MODE NAME BANNER.

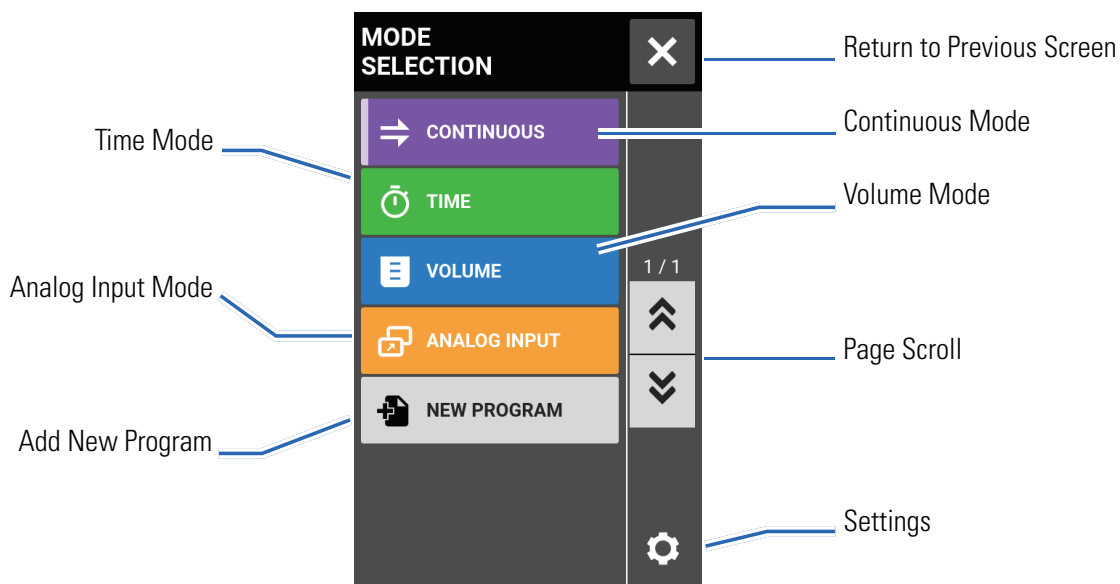

Tap the desired mode or program to access individual mode or program screens.





CONTINUOUS MODE

In Continuous Mode the pump will operate at a selected rpm and/or flow rate until stopped by the user.

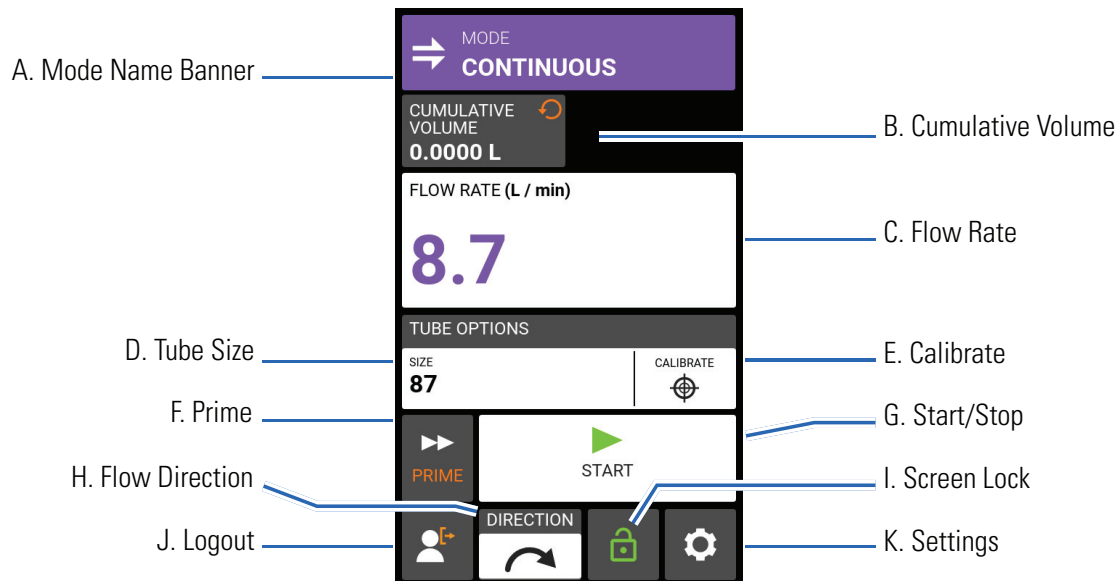
Continuous Mode Run Screen

The Continuous Mode Run Screen is accessed by selecting CONTINUOUS from the Mode Selection Screen.



- A. **MODE NAME BANNER:** Tap the Mode Name Banner to return to the Mode Selection Screen.
- B. **CUMULATIVE VOLUME:** Displays the current cumulative volume of fluid that has been pumped. **To reset the cumulative volume:** Press and hold CUMULATIVE VOLUME RESET  until the display changes to zero.
- C. **FLOW RATE:** Displays the current flow rate in the unit of measurement selected by the user. Tap to access the Flow Rate Screen.
- D. **SIZE:** Tap to access the Tube Size Screen.
- E. **CALIBRATE:** Tap to access the Calibration Screen (for further information see "[Tube Calibration](#)" on page 2-13). Once calibration has been completed for the current tube size Calibration Complete  will be displayed.
- F. **PRIME:** Press and hold to prime the pump drive (for further information see "[Priming the Pump Drive](#)" on page 2-12).
- G. **START/STOP:** Tap START to begin operation. Once operation has commenced STOP  will be displayed.
- H. **FLOW DIRECTION:** Tap DIRECTION to select either clockwise  or counterclockwise .
- I. **SCREEN LOCK:** Locking the screen disables all touchscreen functions. **To lock the screen:** Press and

hold UNLOCKED  until the icon changes to LOCKED  and a red border appears around the screen. **To unlock the screen:** Press and hold LOCKED  until the icon changes to UNLOCKED .











- J. LOGOUT: Tap to log out a user. **NOTE:** This option is only available if User Management is enabled in Settings (for further information see "[User Management](#)" on page 2-8).
- K. SETTINGS: Tap to access the Settings Screen (for further information see "[Settings](#)" on page 2-4).

Continuous Mode Operation

General Preparation:

- Confirm the correct tubing has been selected and is properly loaded into the pump drive (for further information see "[Loading Tubing](#)" on page 2-10).
- Confirm all fluids and containers are ready.
- Switch the drive on using the power switch located at the rear of the drive. **NOTE:** If User Management is enabled you may be prompted for a username and password (For further information see "[User Management](#)" on page 2-8). The touchscreen display will revert to the previously used operation mode.
- Confirm that the tubing has been calibrated by checking that Calibration Complete  is displayed on the Continuous Mode Run Screen (for further information see "[Tube Calibration](#)" on page 2-13).
- If required, prime the pump before operation (for further information see "[Priming the Pump Drive](#)" on page 2-12).

To operate the pump in Continuous Mode:

1. Tap CONTINUOUS from the Mode Selection Screen. The Continuous Mode Run Screen will be displayed.
2. If required, Press and hold CUMULATIVE VOLUME RESET  to reset the display to zero.
3. Select the desired flow rate and flow units:
 - a. Tap FLOW RATE to access the Flow Rate Screen.
 - b. Tap UNITS to access the Flow Units Screen and select the desired flow unit from the available list.
 - c. Tap CONFIRM  to save or CANCEL  to discard changes and return to the Flow Rate Screen.
 - d. Tap FLOW and enter the desired flow rate using the onscreen keypad.
 - e. Tap CONFIRM  to save or CANCEL  to discard changes and return to the Continuous Mode Screen.
4. Tap SIZE. The Tube Size Screen will be displayed.
 - a. Select the desired tube size from the list of available options.
 - b. Tap CONFIRM  to save or CANCEL  to discard changes and return to the Continuous Mode Run Screen.
5. If required, tap CALIBRATE to calibrate the pump for the selected tube and flow rate.
6. Tap DIRECTION to select either clockwise  or counterclockwise  flow direction.
7. Tap START . The drive will commence operation at the flow rate and direction shown.
8. Tap STOP  when the drive operation is no longer required. **NOTE:** In Continuous Mode the drive will continue to operate at the displayed flow rate and direction until stopped.

Saving Continuous Mode Settings as a New Program

Changes made to mode parameters can be saved as a new program for easier access to frequently used settings. **NOTE:** If User Management is enabled only users with authorization can create and modify programs (for further information see "[User Management](#)" on page 2-8).

To save mode parameters to a new program:

1. If required, edit the Continuous Mode settings as desired.
2. Tap MODE NAME BANNER to return to the Mode Selection Screen.
3. Tap NEW PROGRAM. **NOTE:** If NEW PROGRAM is not displayed on the Mode Selection Screen tap SCROLL ▼ to view additional pages.
4. Tap CONTINUOUS. The Continuous New Program Screen will be displayed with the last settings used in the Continuous Mode.
5. Tap PROGRAM1. If required, delete the characters using the back arrow on the onscreen keypad and then enter the desired program name (up to 8 characters).
6. Tap CONFIRM to save or DELETE to cancel.

NOTE:

- Once saved, new programs are added in alphabetical order to the bottom of the Mode Selection Screen.
- If there are multiple programs tapping SCROLL ▼ will display additional pages.





TIME MODE



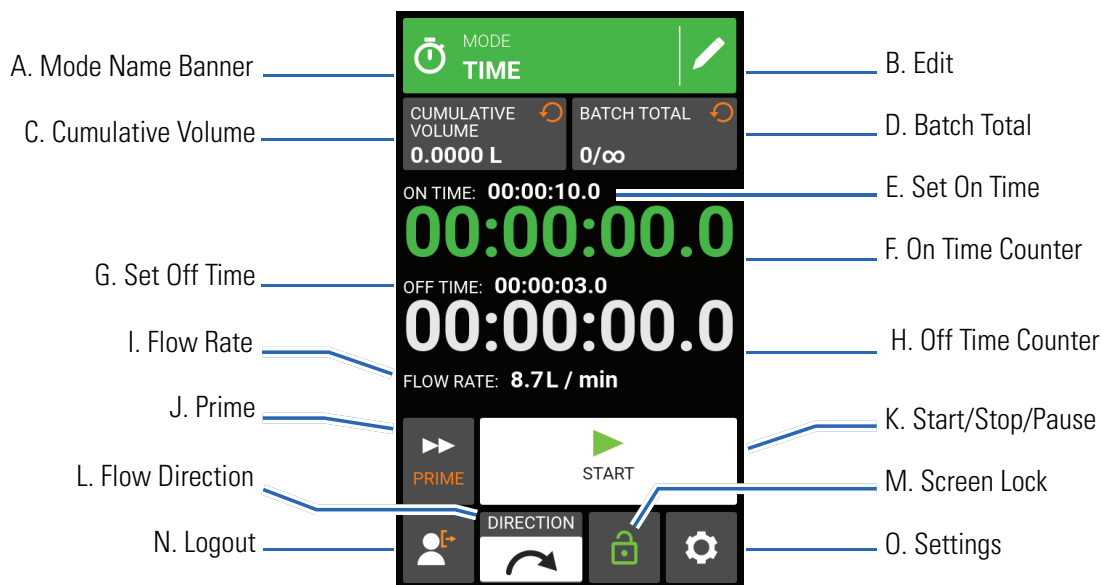



In Time Mode the pump will operate at a selected rpm and/or flow rate for a selected time and/or batch total. At the completion of the selected time or batch total the pump will automatically stop.

Time Mode Run Screen

The Time Mode Run Screen is accessed by selecting TIME from the Mode Selection Screen.



- A. **MODE NAME BANNER:** Tap the Mode Name Banner to return to the Mode Selection Screen.
- B. **EDIT:** Tap to access the Time Mode Edit Screen. From the Time Mode Edit Screen changes can be made to flow rate, flow units, tube size, tube calibration, on time, off time, and batch total.
- C. **CUMULATIVE VOLUME:** Displays the current Cumulative Volume of fluid that has been pumped. **To reset the cumulative volume:** Press and hold CUMULATIVE VOLUME RESET  until the display changes to zero.
- D. **BATCH TOTAL:** Displays the number of dispenses that have been completed in the current batch. **To reset the batch total:** Press and hold BATCH RESET  until the display changes to zero.
- E. **SET ON TIME:** Displays the set dispense operation time.
- F. **ON TIME COUNTER:** Displays a countdown of the set dispense time during operation.
- G. **SET OFF TIME:** Displays the set duration of time the pump pauses between each dispense operation.
- H. **OFF TIME COUNTER:** Displays a countdown of the set off time during operation.
- I. **FLOW RATE:** Displays the current flow rate in the unit of measurement selected by the user.
- J. **PRIME:** Press and hold to prime the pump drive (for further information see "[Priming the Pump Drive](#)" on page 2-12).
- K. **START/STOP/PAUSE:** During operation, the display will change from START  to PAUSE  STOP/RESET .

- L. FLOW DIRECTION: Tap DIRECTION to select either clockwise  or counterclockwise  flow direction.
- M. SCREEN LOCK: Locking the screen disables all touchscreen functions. **To lock the screen:** Press and hold UNLOCKED  until the icon changes to LOCKED  and a red border appears around the screen. **To unlock the screen:** Press and hold LOCKED  until the icon changes to UNLOCKED .
- N. LOGOUT: Tap to log out a user. **NOTE:** This option is only available if User Management is enabled in Settings (for further information see "[User Management](#)" on page 2-8).
- O. SETTINGS: Tap to access the Settings Screen (for further information see "[Settings](#)" on page 2-4).

Time Mode Edit Screen

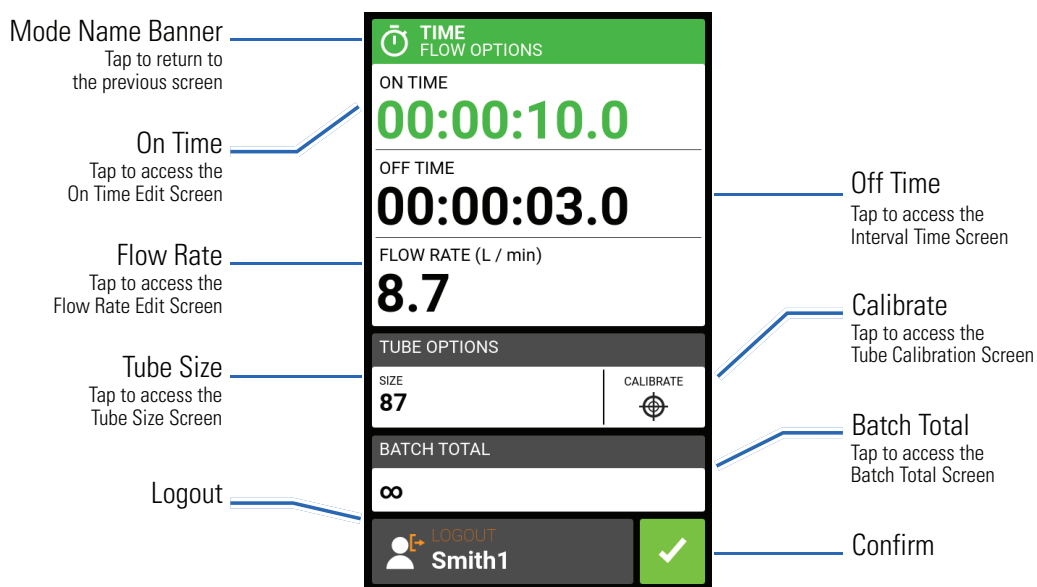























Time Mode Operation

General Preparation:

- Confirm the correct tubing has been selected and is properly loaded into the pump drive (for further information see "[Loading Tubing](#)" on page 2-10).
- Confirm all fluids and containers are ready.
- Switch the drive on using the power switch located at the rear of the drive. **NOTE:** If User Management is enabled you may be prompted for a username and password (For further information see "[User Management](#)" on page 2-8). The touchscreen display will revert to the previously used operation mode.
- Confirm that the tubing has been calibrated by checking that Calibration Complete  is displayed on the Time Mode Edit Screen (for further information see "[Tube Calibration](#)" on page 2-13).
- If required, prime the pump before operation (for further information see "[Priming the Pump Drive](#)" on page 2-12).

To operate the pump in Time Mode:

1. Tap TIME from the Mode Selection Screen. The Time Mode Run Screen will be displayed.
2. Tap EDIT  to access the Time Mode Edit Screen.
3. Tap ON TIME to set the amount of time for each pump operation. The On Time Edit Screen will be displayed.
 - a. Tap HR, MIN, SEC or TENTHS and enter the desired time using the onscreen keypad.
 - b. Tap CONFIRM  to save or CANCEL  to discard changes and return to the Time Mode Edit Screen.
4. Tap OFF TIME to set the amount of time the pump will pause between each operation. The Off Time Edit Screen will be displayed. **NOTE:** If the off time is set to 0 (zero) the pump drive will require a start input (from either the touchscreen or a wired input) to start the next dispense.
 - a. Tap HR, MIN, SEC or TENTHS and enter the desired time using the onscreen keypad.
 - b. Tap CONFIRM  to save or CANCEL  to discard changes and return to the Time Mode Edit Screen.
5. Tap FLOW RATE. The Flow Rate Edit Screen will be displayed.
 - a. Tap UNITS to access the Flow Units Screen and select the desired flow unit from the available list.
 - b. Tap CONFIRM  to save or CANCEL  to discard changes and return to the previous screen.
 - c. Tap FLOW and enter the desired flow rate using the onscreen keypad.
 - d. Tap CONFIRM  to save or CANCEL  to discard changes and return to the Time Mode Edit Screen.
6. Tap SIZE. The Tube Size Screen will be displayed.
 - a. Select the desired tube size from the list of available options.
 - b. Tap CONFIRM  to save or CANCEL  to discard changes and return to the Time Mode Edit Screen.
7. Tap BATCH TOTAL to adjust the number of dispenses in each batch cycle. The Batch Total Screen will be displayed.
 - a. Enter the desired number of dispenses in a batch using the onscreen keypad. **NOTE:** If required, tap INFINITE  to select an infinite number of dispense cycles. If infinite is selected, the pump will run continuously.
 - b. Tap CONFIRM  to save or CANCEL  to discard changes and return to the Time Mode Edit Screen.
8. Tap CONFIRM  to return to the Time Dispense Mode Run Screen.
9. Tap DIRECTION to select either clockwise  or counterclockwise  flow direction.
10. Tap START . The pump will now operate until the batch total is completed or until PAUSE  or STOP  is tapped.
11. If required, adjustments can be made to any of the Time Mode option settings during operation. To make any adjustments:
 - a. Tap PAUSE  and then repeat steps 2–9 above.
 - b. Tap CONTINUE  to complete the pump operation once the desired changes have been made.

Saving Time Mode Settings as a New Program

Changes made to mode parameters can be saved as a new program for easier access to frequently used settings.

NOTE: If User Management is enabled only users with authorization can create and modify programs (for further information see "[User Management](#)" on page 2-8).

To save mode parameters to a new program:

1. If required, edit the Time Mode settings as desired.
2. Tap MODE NAME BANNER to return to the Mode Selection Screen.
3. Tap NEW PROGRAM. **NOTE:** If NEW PROGRAM is not displayed on the Mode Selection Screen tap SCROLL ▼ to view additional pages.
4. Tap TIME. The Time New Program Screen will be displayed with the last settings used in the Time Mode.
5. Tap PROGRAM1. If required, delete the characters using the back arrow on the onscreen keypad and then enter the desired program name (up to 8 characters).
6. Tap CONFIRM to save or DELETE to cancel.

NOTE:

- Once saved, new programs are added in alphabetical order to the bottom of the Mode Selection Screen.
- If there are multiple programs tapping SCROLL ▼ will display additional pages.



VOLUME MODE

In Volume Mode the pump will operate at a selected rpm and/or flow rate until a selected volume of fluid has been pumped. When the selected volume has been pumped the drive will automatically stop.

Volume Mode Run Screen

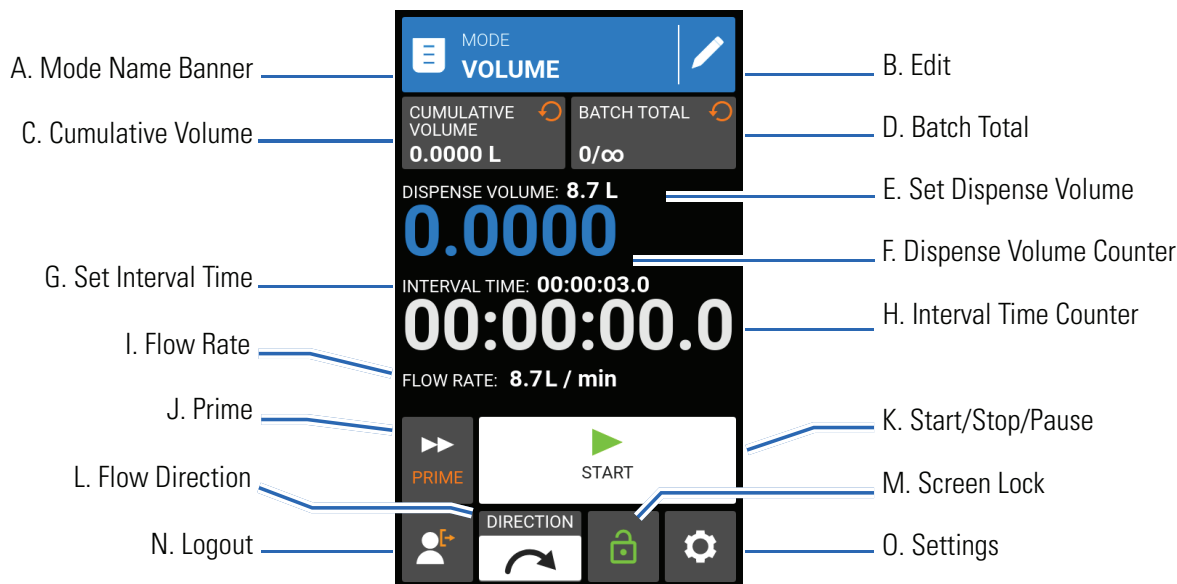
The Volume Mode Run Screen is accessed by selecting VOLUME from the Mode Selection Screen.



- A. **MODE NAME BANNER:** Tap the Mode Name Banner to return to the Mode Selection Screen.
- B. **EDIT:** Tap to access the Volume Mode Edit Screen. From the Volume Mode Edit Screen adjustments can be made to dispense volume, interval time, flow rate, tube options, calibration and batch total. **NOTE:** Edit is inactive during operation.
- C. **CUMULATIVE VOLUME:** Displays the current Cumulative Volume of fluid that has been pumped. **To reset the cumulative volume:** Press and hold CUMULATIVE VOLUME RESET  until the display changes to zero.
- D. **BATCH TOTAL:** Displays the number of dispenses that have been completed in the current batch. **To reset the batch total:** Press and hold BATCH RESET  until the display changes to zero.
- E. **SET DISPENSE VOLUME:** Displays the selected volume of fluid for dispensing.
- F. **DISPENSE VOLUME COUNTER:** Displays a countdown of the fluid volume during operation.
- G. **SET INTERVAL TIME:** Displays the set time the pump pauses between dispenses.
- H. **INTERVAL TIME COUNTER:** Displays a countdown of the set interval time during operation.
- I. **FLOW RATE:** Displays the current flow rate in the unit of measurement selected by the user.
- J. **PRIME:** Press and hold to prime the pump drive (for further information see "[Priming the Pump Drive](#)" on page 2-12).

- K. START/STOP/PAUSE: During operation, the display will change from START ► to PAUSE || STOP/RESET ■.
- L. FLOW DIRECTION: Tap DIRECTION to select either clockwise ↻ or counterclockwise ↺ flow direction.
- M. SCREEN LOCK: Locking the screen disables all touchscreen functions. **To lock the screen:** Press and hold UNLOCKED 🗝 until the icon changes to LOCKED 🔒 and a red border appears around the screen. **To unlock the screen:** Press and hold LOCKED 🔒 until the icon changes to UNLOCKED 🗝.
- N. LOGOUT: Tap to log out a user. **NOTE:** This option is only available if User Management is enabled in Settings (for further information see "[User Management](#)" on page 2-8).
- O. SETTINGS: Tap to access the Settings Screen (for further information see "[Settings](#)" on page 2-4).

Volume Mode Edit Screen

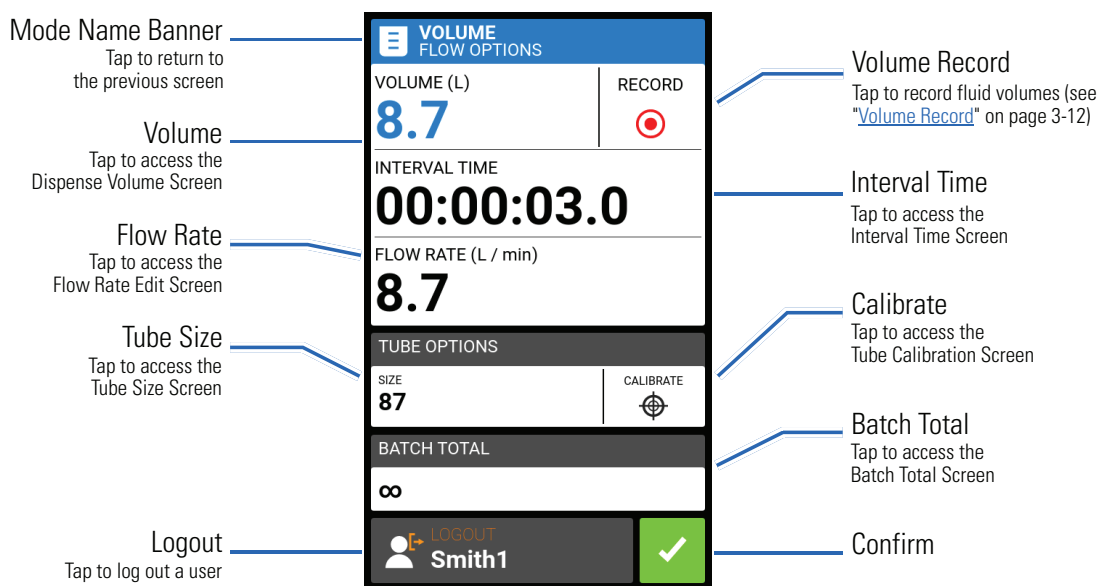























Volume Dispense Mode Operation

General Preparation:

- Confirm the correct tubing has been selected and is properly loaded into the pump drive (for further information see "[Loading Tubing](#)" on page 2-10).
- Confirm all fluids and containers are ready.
- Switch the drive on using the power switch located at the rear of the drive. **NOTE:** If User Management is enabled you may be prompted for a username and password (For further information see "[User Management](#)" on page 2-8). The touchscreen display will revert to the previously used operation mode.
- Confirm that the tubing has been calibrated by checking that Calibration Complete 🌀 is displayed on the Volume Mode Edit Screen (for further information see "[Tube Calibration](#)" on page 2-13).
- If required, prime the pump before operation (for further information see "[Priming the Pump Drive](#)" on page 2-12).

To operate the pump in Volume Mode:

1. Tap VOLUME from the Mode Selection Screen. The Volume Mode Run Screen will be displayed.
2. Tap EDIT  to access the Volume Mode Edit Screen.
3. Tap VOLUME. The Dispense Volume Screen will be displayed.
 - a. Tap VOLUME and enter the desired volume using the onscreen keypad. **NOTE:** If the volume of fluid is unknown the pump drive can record fluid dispense volumes (for further information see "[Volume Record](#)" on page 3-12).
 - b. Tap RAMP UP  to set the time the pump takes to reach full flow rate (between 0 and 60 seconds) using the onscreen keypad.
 - c. Tap RAMP DOWN  to set the time the pump takes to stop at the end of each dispense operation (between 0 and 60 seconds) using the onscreen keypad.
 - d. Tap CONFIRM  to save or CANCEL  to discard changes and return to the Volume Mode Edit Screen.
4. Tap INTERVAL TIME to set the amount of time the pump will pause between each operation. The Interval Time Screen will be displayed. **NOTE:** If the interval time is set to 0 (zero) the pump drive will require a start input (from either the touchscreen or a wired input) to start the next dispense.
 - a. Tap HR, MIN, SEC or TENTHS and enter the desired time using the onscreen keypad.
 - b. Tap CONFIRM  to save or CANCEL  to discard changes and return to the Volume Mode Edit Screen.
5. Tap FLOW RATE. The Flow Rate Edit Screen will be displayed.
 - a. Tap UNITS to access the Flow Units Screen and select the desired flow unit from the available list.
 - b. Tap CONFIRM  to save or CANCEL  to discard changes and return to the previous screen.
 - c. Tap FLOW and enter the desired flow rate using the onscreen keypad.
 - d. Tap CONFIRM  to save or CANCEL  to discard changes and return to the Volume Mode Edit Screen.
6. Tap SIZE. The Tube Size Screen will be displayed.
 - a. Select the desired tube size from the list of available options.
 - b. Tap CONFIRM  to save or CANCEL  to discard changes and return to the Volume Mode Edit Screen.
7. Tap BATCH TOTAL to adjust the number of dispenses in each batch cycle. The Batch Total Screen will be displayed.
 - a. Enter the desired number of dispenses in a batch using the onscreen keypad. **NOTE:** If required, tap INFINITE  to select an infinite number of dispense cycles. If infinite is selected, the pump will run continuously.
 - b. Tap CONFIRM  to save or CANCEL  to discard changes and return to the Volume Mode Edit Screen.
8. Tap DIRECTION to select either clockwise  or counterclockwise  flow direction.
9. Tap START . The pump will now operate until the batch total is completed or until PAUSE  or STOP  is tapped.

10. If required, adjustments can be made to any of the Volume Mode option settings during operation. To make any adjustments:
 - a. Tap PAUSE  and then repeat steps 2–10 above.
 - b. Tap CONTINUE  to complete the pump operation once the desired changes have been made.

Saving Volume Mode Settings as a New Program

Changes made to mode parameters can be saved as a new program for easier access to frequently used settings. **NOTE:** If User Management is enabled only users with authorization can create and modify programs (for further information see "[User Management](#)" on page 2-8).

To save mode parameters to a new program:

1. If required, edit the Volume Mode settings as desired.
2. Tap MODE NAME BANNER to return to the Mode Selection Screen.
3. Tap NEW PROGRAM. **NOTE:** If NEW PROGRAM is not displayed on the Mode Selection Screen tap SCROLL  to view additional pages.
4. Tap VOLUME. The Volume New Program Screen will be displayed with the last settings used in the Volume Mode.
5. Tap PROGRAM1. If required, delete the characters using the back arrow on the onscreen keypad and then enter the desired program name (up to 8 characters).
6. Tap CONFIRM to save or DELETE to cancel.

NOTE:

- Once saved, new programs are added in alphabetical order to the bottom of the Mode Selection Screen.
- If there are multiple programs tapping SCROLL  will display additional pages.



Volume Record











The Volume Record feature can be used to record unknown fluid volumes.

General Preparation:

- Confirm the correct tubing has been selected and is properly loaded into the pump drive (for further information see "[Loading Tubing](#)" on page 2-10).
- Confirm all fluids and containers are ready.
- Confirm that the tubing has been calibrated by checking that Calibration Complete  is displayed on the Volume Mode Edit Screen (for further information see "[Tube Calibration](#)" on page 2-13).
- If required, prime the pump before operation (for further information see "[Priming the Pump Drive](#)" on page 2-12).

To record a fluid volume:

1. Tap VOLUME from the Mode Selection Screen. The Volume Mode Run Screen will be displayed.
2. Tap EDIT  to access the Volume Mode Edit Screen.
3. Tap RECORD . The Record Dispense Screen will be displayed.

4. Tap FLOW RATE to make adjustments to the flow rate. The Flow Rate Screen will be displayed.
 - a. Tap FLOW to enter the desired flow rate using the onscreen keypad.
 - b. Tap UNITS to enter the desired flow rate units using the onscreen keypad.
 - c. Tap CONFIRM  to save changes and return to the Record Dispense Screen.
5. Tap START . The drive will now begin pump operation while recording the fluid volume.
6. If required, adjustments can be made to flow rate during operation. To make adjustments:
 - a. Tap STOP  and then repeat steps 4–6 above.
 - b. Tap START  to complete the pump operation once the desired changes have been made. **NOTE:** If required, tap STOP  and then CANCEL  to discard recording and return to the Volume Mode Edit Screen.
7. Tap STOP  when the desired volume of fluid has been pumped. The recorded dispense volume will now be displayed under VOLUME.
8. Tap CONFIRM  to save or CANCEL  to discard recording and return to the Volume Mode Edit Screen. If saved, the recorded dispense volume will now be displayed under VOLUME.
9. Tap CONFIRM . The Volume Mode Run Screen will be displayed.

ANALOG INPUT MODE



CAUTION: Power must be turned off before connecting the external analog control cable to prevent damage to the drive.

The B/T Digital Pump Drive can be controlled and monitored through the pump drive's 31-Pin female connection port. See www.masterflex.com for more information.

Analog Input Mode Run Screen

The Analog Input Mode Run Screen will be displayed on the pump drive's touchscreen during analog input operation. The screen displays the currently selected operation dispense settings from an external remote control device. The Analog Input Mode Run Screen is accessed by selecting ANALOG INPUT from the Mode Selection Screen.

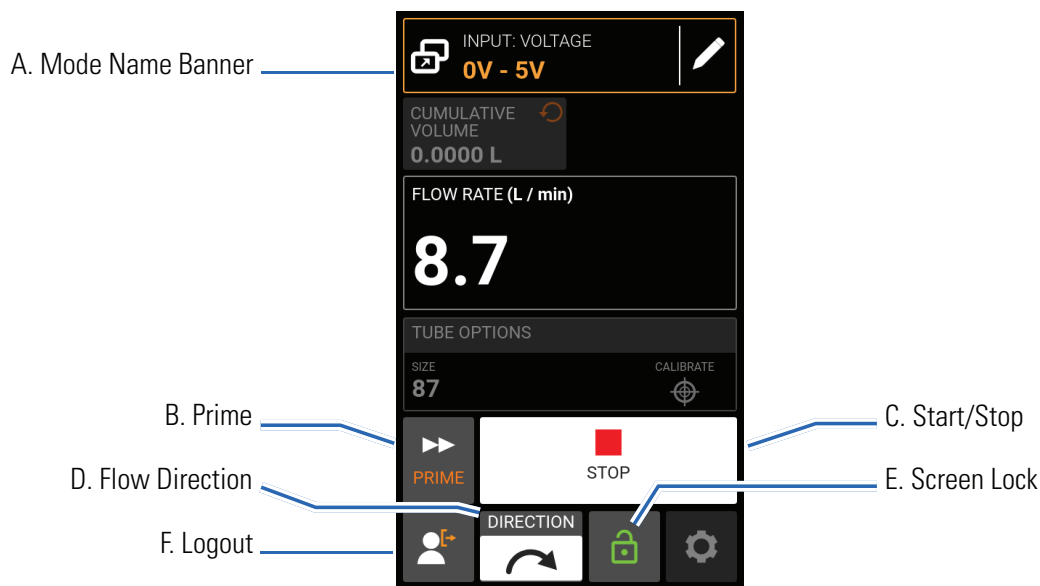

- MODE NAME BANNER:** Displays the Mode Name as well as the currently selected input type (ANALOG CURRENT or ANALOG VOLTAGE). Tap the Mode Name Banner to return to the Mode Selection Screen.
- PRIME:** Press and hold to prime the pump drive (for further information see "[Priming the Pump Drive](#)" on page 2-12).
- START/STOP:** During operation, the display will change from START ► to STOP ■.
- FLOW DIRECTION:** Tap DIRECTION to select either clockwise ↻ or counterclockwise ↻ flow direction.
- SCREEN LOCK:** Locking the screen disables all touchscreen functions. **To lock the screen:** Press and hold UNLOCKED 🗝 until the icon changes to LOCKED 🔒 and a red border appears around the screen. **To unlock the screen:** Press and hold LOCKED 🔒 until the icon changes to UNLOCKED 🗝.

- F. LOGOUT: Tap to log out a user. **NOTE:** This option is only available if User Management is enabled in Settings (for further information see "[User Management](#)" on page 2-8).

Analog Input



CAUTION: Power must be turned off before connecting the external analog control cable to prevent damage to the drive.



The B/T supports and controls analog input using suitable equipment through the pump drive's 31-Pin female connection port. Analog input can be used in place of, or in addition to, MasterflexLive™.

See also "[31-Pin Electrical Connections](#)" on page 4-5.

General Preparation:

- Confirm the correct tubing has been selected and is properly loaded into the pump drive (for further information see "[Loading Tubing](#)" on page 2-10).
- Confirm all fluids and containers are ready.
- Switch the drive on using the power switch located at the rear of the drive. **NOTE:** If User Management is enabled you may be prompted for a username and password (For further information see "[User Management](#)" on page 2-8). The touchscreen display will revert to the previously used operation mode.
- Confirm that the tubing has been calibrated by checking that Calibration Complete  is displayed on the Analog Input Mode Run Screen (for further information see "[Tube Calibration](#)" on page 2-13).
- If required, prime the pump before operation (for further information see "[Priming the Pump Drive](#)" on page 2-12).
- Confirm that the pump drive is connected to the appropriate equipment through the drive's 31-Pin female connection port.

To operate analog input control and monitoring:

1. Tap ANALOG INPUT from the Mode Selection Screen. The Analog Input Mode Run Screen will be displayed.
2. Tap EDIT . The Analog Input Mode Edit Screen will be displayed.
3. Tap the desired analog input type from the available list.
4. If using either ANALOG: VOLTAGE or ANALOG: CURRENT:
 - a. Select the desired current or voltage operating range from the available list.
 - b. Tap CONFIRM  to save or CANCEL  to cancel and return to the previous screen.

NOTE:

- Tap STOP  on the pump drive touchscreen to override the remote control device and immediately stop the pump operation. **NOTE:** If locked, the screen will need to be unlocked before the pump operation can be stopped.
- See www.masterflex.com for further information on using analog input remote control and monitoring.

Saving Analog Input Mode Settings as a New Program

Changes made to mode parameters can be saved as a new program for easier access to frequently used mode settings. **NOTE:** If User Management is enabled only users with authorization can create and modify programs (for further information see "[User Management](#)" on page 2-8).

To save mode parameters to a new program:

1. If required, edit the Analog Input Mode settings as desired.
2. Tap MODE NAME BANNER to return to the Mode Selection Screen.
3. Tap NEW PROGRAM. **NOTE:** If NEW PROGRAM is not displayed on the Mode Selection Screen tap SCROLL ▼ to view additional pages.
4. Tap ANALOG INPUT. The Analog Input New Program Screen will be displayed with the last settings used in the Analog Input Mode.
5. Tap PROGRAM1. If required, delete the characters using the back arrow on the onscreen keypad and then enter the desired program name (up to 8 characters).
6. Tap CONFIRM to save or DELETE to cancel.

NOTE:

- Once saved, new programs are added in alphabetical order to the bottom of the Mode Selection Screen.
- If there are multiple programs tapping SCROLL ▼ will display additional pages.

MASTERFLEXLIVE™

The B/T Digital Pump Drive can be monitored through the MasterflexLive™ website using an Ethernet or Wi-Fi connection. MasterflexLive™ can be accessed from any suitable digital device connected to the internet, such as a laptop, tablet, smartphone or desktop computer. See www.masterflex.com for more information.









CUSTOM PROGRAM MODES

Custom programs allow users to create easily accessible programs for frequently used pump mode settings.

NOTE: If User Management is enabled only users with authorization can create and modify programs (for further information see "[User Management](#)" on page 2-8).

Adding a New Program: Continuous Mode

To add a new Continuous Mode program:

















1. Tap NEW PROGRAM from the Mode Selection Screen. The New Program Screen will be displayed.
NOTE: If NEW PROGRAM is not displayed on the Mode Selection Screen tap SCROLL  to view additional pages.
2. Tap CONTINUOUS. The Continuous New Program Screen will be displayed.
3. Tap PROGRAM1. If required, delete the characters using the back arrow on the onscreen keypad and then enter the desired program name (up to 8 characters).
4. Select the desired flow rate and flow units:
 - a. Tap FLOW RATE to access the Flow Rate Screen.
 - b. Tap UNITS to access the Flow Units Screen and select the desired flow unit from the available list.
 - c. Tap CONFIRM  to save or CANCEL  to discard changes and return to the Flow Rate Screen.
 - d. Tap FLOW and enter the desired flow rate using the onscreen keypad.
 - e. Tap CONFIRM  to save or CANCEL  to discard changes and return to the Continuous New Program Screen.
5. Tap SIZE. The Tube Size Screen will be displayed.
 - a. Select the desired tube size from the list of available options.
 - b. Tap CONFIRM  to save or CANCEL  to discard changes and return to the Continuous New Program Screen.
6. Tap DIRECTION to select either clockwise  or counterclockwise  flow direction.
7. Tap CONFIRM to save or DELETE to discard changes.

NOTE:

- Once saved, new programs are added in alphabetical order to the bottom of the Mode Selection Screen.
- If there are multiple programs tapping SCROLL  will display additional pages.

Adding a New Program: Time Mode

To add a new Time Mode program:

















1. Tap NEW PROGRAM from the Mode Selection Screen. The New Program Screen will be displayed. **NOTE:** If NEW PROGRAM is not displayed on the Mode Selection Screen tap SCROLL  to view additional pages.
2. Tap TIME. The Time New Program Screen will be displayed.
3. Tap PROGRAM1. If required, delete the characters using the back arrow on the onscreen keypad and then enter the desired program name (up to 8 characters).
4. Tap ON TIME to set the amount of time for each pump operation. The On Time Edit Screen will be displayed.
 - a. Tap HR, MIN, SEC or TENTHS and enter the desired time using the onscreen keypad.
 - b. Tap CONFIRM  to save or CANCEL  to discard changes and return to the Time New Program Screen.
5. Tap OFF TIME to set the amount of time the pump will pause between each operation. The Off Time Edit Screen will be displayed. **NOTE:** If the off time is set to 0 (zero) the pump drive will require a start input (from either the touchscreen or a wired input) to start the next dispense.
 - a. Tap HR, MIN, SEC or TENTHS and enter the desired time using the onscreen keypad.
 - b. Tap CONFIRM  to save or CANCEL  to discard changes and return to the Time New Program Screen.
6. Tap FLOW RATE. The Flow Rate Edit Screen will be displayed.
 - a. Tap UNITS to access the Flow Units Screen and select the desired flow unit from the available list.
 - b. Tap CONFIRM  to save or CANCEL  to discard changes and return to the previous screen.
 - c. Tap FLOW and enter the desired flow rate using the onscreen keypad.
 - d. Tap CONFIRM  to save or CANCEL  to discard changes and return to the Time New Program Screen.
7. Tap SIZE. The Tube Size Screen will be displayed.
 - a. Select the desired tube size from the list of available options.
 - b. Tap CONFIRM  to save or CANCEL  to discard changes and return to the Time New Program Screen.
8. Tap DIRECTION to select either clockwise  or counterclockwise  flow direction.
9. Tap BATCH TOTAL to adjust the number of dispenses in each batch cycle. The Batch Total Screen will be displayed.
 - a. Enter the desired number of dispenses in a batch using the onscreen keypad. **NOTE:** If required, tap INFINITE  to select an infinite number of dispense cycles. If infinite is selected, the pump will run continuously.
 - b. Tap CONFIRM  to save or CANCEL  to discard changes and return to the Time New Program Screen.
10. Tap CONFIRM to save or DELETE to discard changes.

NOTE:



- Once saved, new programs are added in alphabetical order to the bottom of the Mode Selection Screen.
- If there are multiple programs tapping SCROLL  will display additional pages.

Adding a New Program: Volume Mode

To add a new Volume Mode program:

1. Tap NEW PROGRAM from the Mode Selection Screen. The New Program Screen will be displayed. **NOTE:** If NEW PROGRAM is not displayed on the Mode Selection Screen tap SCROLL  to view additional pages.
2. Tap VOLUME. The Volume New Program Screen will be displayed.
3. Tap PROGRAM1. If required, delete the characters using the back arrow on the onscreen keypad and then enter the desired program name (up to 8 characters).
4. Tap VOLUME. The Dispense Volume Screen will be displayed.
 - a. Tap VOLUME and enter the desired volume using the onscreen keypad. **NOTE:** If the volume of fluid is unknown the pump drive can record fluid dispense volumes (for further information see "[Volume Record](#)" on page 3-12).
 - b. Tap RAMP UP  to set the time the pump takes to reach full flow rate (between 0 and 60 seconds) using the onscreen keypad.
 - c. Tap RAMP DOWN  to set the time the pump takes to stop at the end of each dispense operation (between 0 and 60 seconds) using the onscreen keypad.
 - d. Tap CONFIRM  to save or CANCEL  to discard changes and return to the Volume New Program Screen.
5. Tap INTERVAL TIME to set the amount of time the pump will pause between each operation. The Interval Time Screen will be displayed. **NOTE:** If the interval time is set to 0 (zero) the pump drive will require a start input (from either the touchscreen or a wired input) to start the next dispense.
 - a. Tap HR, MIN, SEC or TENTHS and enter the desired time using the onscreen keypad.
 - b. Tap CONFIRM  to save or CANCEL  to discard changes and return to the Volume New Program Screen.
6. Tap FLOW RATE. The Flow Rate Edit Screen will be displayed.
 - a. Tap UNITS to access the Flow Units Screen and select the desired flow unit from the available list.
 - b. Tap CONFIRM  to save or CANCEL  to discard changes and return to the previous screen.
 - c. Tap FLOW and enter the desired flow rate using the onscreen keypad.
 - d. Tap CONFIRM  to save or CANCEL  to discard changes and return to the Volume New Program Screen.
7. Tap SIZE. The Tube Size Screen will be displayed.
 - a. Select the desired tube size from the list of available options.
 - b. Tap CONFIRM  to save or CANCEL  to discard changes and return to the Volume New Program Screen.
8. Tap DIRECTION to select either clockwise  or counterclockwise  flow direction.
9. Tap BATCH TOTAL to adjust the number of dispenses in each batch cycle. The Batch Total Screen will be displayed.
 - a. Enter the desired number of dispenses in a batch using the onscreen keypad. **NOTE:** If required, tap INFINITE  to select an infinite number of dispense cycles. If infinite is selected, the pump will run

continuously.







- b. Tap CONFIRM  to save or CANCEL  to discard changes and return to the Volume New Program Screen.

NOTE:

- Once saved, new programs are added in alphabetical order to the bottom of the Mode Selection Screen.
- If there are multiple programs tapping SCROLL  will display additional pages.

Adding a New Program: Analog Input Mode

To add a new Analog Mode program:

1. Tap NEW PROGRAM from the Mode Selection Screen. The New Program Screen will be displayed.
NOTE: If NEW PROGRAM is not displayed on the Mode Selection Screen tap SCROLL  to view additional pages.
2. Tap ANALOG INPUT. The Analog Input New Program Screen will be displayed.
3. Tap PROGRAM1. If required, delete the characters using the back arrow on the onscreen keypad and then enter the desired program name (up to 8 characters).
4. Tap INPUT. The Analog Type Screen will be displayed.
5. Tap the desired analog type from the available list.
6. If using either ANALOG: VOLTAGE or ANALOG: CURRENT:
 - a. Select the desired current or voltage operating range from the available list.
 - b. Tap CONFIRM  to save or CANCEL  to cancel and return to the Analog Input New Program Screen.
7. Tap SIZE. The Tube Size Screen will be displayed.
 - a. Select the desired tube size from the list of available options.
 - b. Tap CONFIRM  to save or CANCEL  to discard changes and return to the Analog Input New Program Screen.
8. Tap DIRECTION to select either clockwise  or counterclockwise  flow direction.
9. Tap CONFIRM to save or DELETE to discard changes.



NOTE:

- Once saved, new programs are added in alphabetical order to the bottom of the Mode Selection Screen.
- If there are multiple programs tapping SCROLL  will display additional pages.



Using Program Modes

Custom programs will appear in alphabetical order at the bottom of the Mode Selection Screen. If there are multiple programs tapping SCROLL  will display additional pages.

General Preparation:

- Confirm the correct tubing has been selected and is properly loaded into the pump drive (for further information see "[Loading Tubing](#)" on page 2-10).
- Confirm all fluids and containers are ready.
- Switch the drive on using the power switch located at the rear of the drive. **NOTE:** If User Management is enabled you may be prompted for a username and password (For further information see "[User Management](#)" on page 2-8). The touchscreen display will revert to the previously used operation mode.
- Confirm that the tubing has been calibrated by checking that Calibration Complete  is displayed on the Program Information  Screen (for further information see "[Tube Calibration](#)" on page 2-13).
- If required, prime the pump before operation (for further information see "[Priming the Pump Drive](#)" on page 2-12).

To use a program:

1. Select the desired program from the Mode Selection Screen. The Program Run Screen will be displayed.
2. Tap START  to begin the pump drive operation using the displayed program settings.
3. If required, Tap PAUSE  or STOP  during operation. **NOTE:** The pump cannot be paused during Continuous Mode operation.





NOTE:

- Tap INFORMATION  to view the selected program's settings.
- Individual settings cannot be edited from the Program Run Screen.

Editing a Program

NOTE: If User Management is enabled only users with authorization can create and modify programs (for further information see "[User Management](#)" on page 2-8).



To edit a program:

1. Tap EDIT  located next to the desired program name on the Mode Selection Screen (**NOTE:** If there are multiple programs, tap SCROLL  to display additional pages). The Program Edit Screen will be displayed.
2. Edit the settings for the selected mode as desired. For instructions on editing individual mode settings see:
 - "[Adding a New Program: Continuous Mode](#)" on page 3-17.
 - "[Adding a New Program: Time Mode](#)" on page 3-17.
 - "[Adding a New Program: Volume Mode](#)" on page 3-19.
 - "[Adding a New Program: Analog Input Mode](#)" on page 3-20.
 - **NOTE:** Once the individual mode settings have been edited and saved the Program Edit Screen will be displayed.
3. Tap CONFIRM  to save or CANCEL  to discard changes and return to the Mode Selection Screen.

Deleting a Program

NOTE: If User Management is enabled only users with authorization can delete a program (For further information see "[User Management](#)" on page 2-8).

To delete a program:

1. Tap EDIT  located next to the desired program name on the Mode Selection Screen (**NOTE:** if there are multiple programs tap SCROLL  to display additional pages). The Program Edit Screen will be displayed.
2. Tap DELETE PROGRAM .
3. Tap DELETE to delete the program and return to the Mode Selection Screen or CANCEL to return to the previous screen.

SECTION 4: COMMUNICATION SPECIFICATION

ETHERNET/IP MODE

In Ethernet/IP mode, the pump can be operated in Continuous, Volume and Time modes. The pump drives are equipped with Ethernet/IP for real time control via a PLC. The .EDS command file is available for download on the ODVA website:

<https://marketplace.odva.org/products/1923-masterflex?lang=en>

Ethernet/IP Setup

Ensure that your Pump and PLC along with your computer are all connected to the same network. Also, make sure the computer's IP address is within the subnet mask range of the PLC and the pump. The default addressing methods for the pump is DHCP. Static IP address may be assigned through the Ethernet settings menu.

The screenshot shows the 'ETHERNET SETTINGS' menu. At the top, there are two buttons: a grey 'X' and a green checkmark. Below this, there are two radio button options: 'DHCP' (which is selected with a green dot) and 'STATIC'. Under 'DHCP', the following settings are displayed: IP ADDRESS 192.168.1.7, DNS 1 192.168.1.1, SUBNET MASK 255.255.255.0, DNS 2, and ROUTER 192.168.1.1.

The screenshot shows the 'ETHERNET SETTINGS' menu with 'STATIC' selected. The settings are: IP ADDRESS 192.168.0.1, DNS 1 8.8.4.4, SUBNET MASK 255.255.255.0, DNS 2, and ROUTER 192.168.1.1. Below the settings is a numeric keypad with buttons for 7, 8, 9, 4, 5, 6, 1, 2, 3, a decimal point, 0, and a CLEAR button.

In the device menu, enable the Ethernet/IP feature by toggling to select ON.

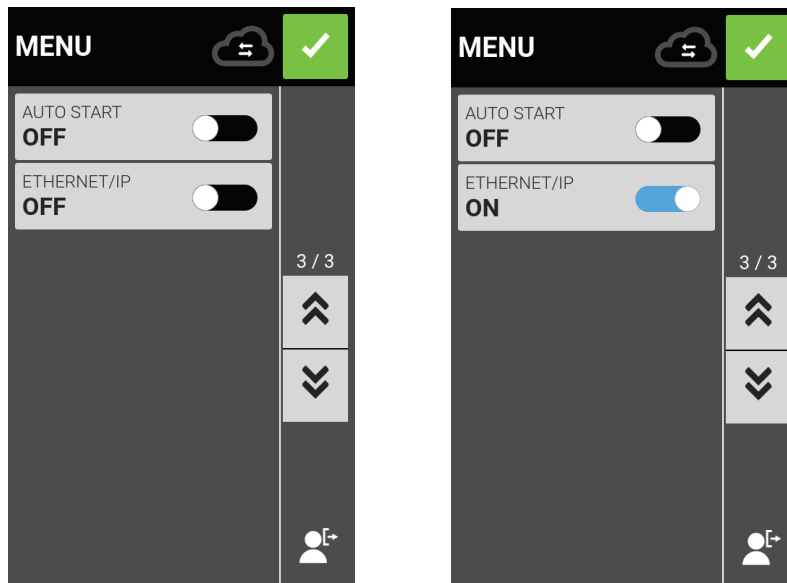

Once enable, the following message appears on the UI. Press Accept on this screen.

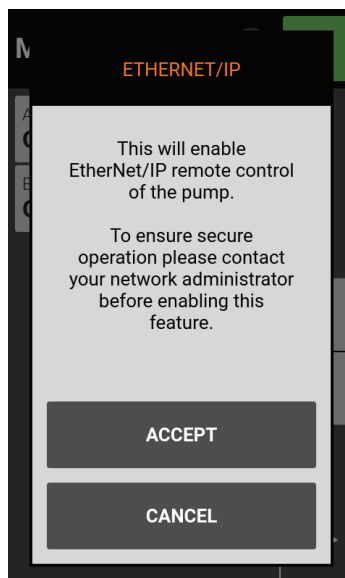

Once the Ethernet/IP has been configured and enabled, you will now be able to view the pump from your PLC. To enable remote control, you must configure the pump from your PLC using the bit "Pump1:O.Toggle_Local_Control_1_to_0".

NOTE:

- The bit changes state from local to remote on a 1 to 0 transition.
- Once enabled, the Ethernet/IP banner will appear at the top of the pump screen.

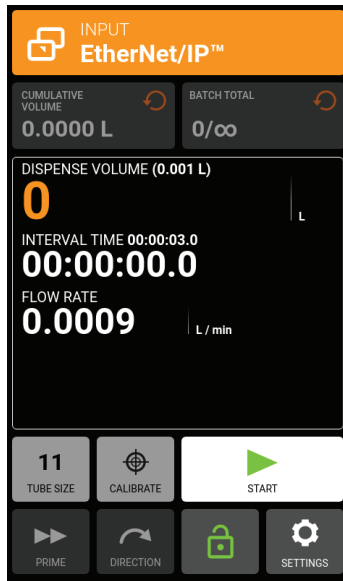

Shows Ethernet/IP active in volume Dispense Mode

MASTERFLEX ETHERNET/IP

Input data; 56 bytes of input data from pump to master.

Bytes	Data Type	Description
0-3	32-Bit INT	<u>Pump Status</u> Bit 0: Status OK Bit 1: Pump Running Bit 2: Dispense Running Bit 3: Tube Uncalibrated Bit 4: Head Open Bit 5: Reserved Bit 6: Flow Direction CCW Bit 7: Remote Control Bit 8-31: Reserved
4	BYTE	Dispense Mode
5	BYTE	Tube Size
6	BYTE	Flow Units
7	BYTE	Reserved Pad
8 - 11	FLOAT	Cumulative Volume
12 - 15	FLOAT	Remaining Dispense Volume
16 - 19	FLOAT	Remaining Dispense On Seconds
20 - 23	FLOAT	Remaining Dispense Off Seconds
24 - 27	32- bit INT	Batch Count Current
28 - 31	32- bit INT	Batch Count Total
32 - 35	FLOAT	Minimum Flow Rate
36 - 39	FLOAT	Current Flow Rate
40 - 43	FLOAT	Maximum Flow Rate
44 - 45	16- bit INT	Remaining Dispense On Time Days
46	BYTE	Remaining Dispense On Time Hours
47	BYTE	Remaining Dispense On Time Minutes
48	BYTE	Remaining Dispense On Time Seconds
49	BYTE	Remaining Dispense On Time Tenths
50 - 51	16- bit INT	Remaining Dispense Off Time Days
52	BYTE	Remaining Dispense Off Time Hours
53	BYTE	Remaining Dispense Off Time Minutes
54	BYTE	Remaining Dispense Off Time Seconds
55	BYTE	Remaining Dispense Off Time Tenths

Output data; 28 bytes of output data from master to pump.

Bytes	Data Type	Description
0	BYTE	Pump Control Bit 0: Run/Pause (1 = RUN; 0 = PAUSE) Bit 1: Stop and Reset Dispense (1 to 0 transition) Bit 2: Toggle Remote/Local Control (1 to 0 transition) Bit 3: Clear Cumulative Volume (1 to 0 transition) Bit 4: Reserved Bit 5: Reserved Bit 6: Set Flow Direction CCW (1 = CCW, 0 = CW) Bit 7: Reserved
1	BYTE	Reserved Pad
2	BYTE	Reserved Pad
3	BYTE	Reserved Pad
4	BYTE	Set Dispense Mode (0 = CONT, 1 = TIME, 2 = VOL)
5	BYTE	Reserved Pad
6	BYTE	Set Flow Units (see Table 3)
7	BYTE	Reserved pad
8 - 11	FLOAT	Set Flow Rate
12 - 15	FLOAT	Set Dispense Volume
16 - 19	FLOAT	Set Dispense On Seconds
20 - 23	FLOAT	Set Dispense Off Seconds
24 - 27	32- bit INT	Set Batch Count Total (0 = infinite)

Masterflex Flow Units Correlation Table

Index	321 RPM B/T
1	mL/min
2	mL/hr
3	L/min
4	L/hr
5	L/day
6	uL/min
7	uL/hr
8	gal/min
9	gal/hr
10	gal/day
11	oz/min
12	oz/hr
13	cum/hr
14	RPM
15	%

PROFIBUS

Profibus Mode

In Profibus mode the pump will be operated remotely either in Continuous, Volume or Time mode.

Profibus Setup

Ensure your computer and the PLC are both connected to a network switch. Also verify the pump can send/receive ping commands from your computer. Connect the DB-9 Profibus cable on both the pump side as well as the Profibus connector either on the Profibus module or the controller itself.

Profibus Settings

NOTE: Assuming the pump is online with the PLC and has been toggled into Profibus mode:

To Select Profibus Settings:

1. Tap SETTINGS .
2. From the resulting MENU screen SCROLL  down to page 3/3 and access PROFIBUS SETTINGS.

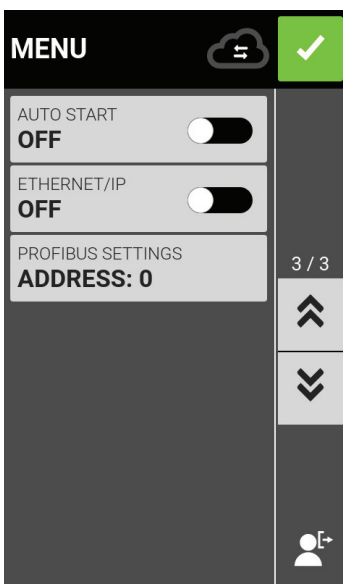

3. Once that field is selected you now enter the PROFIBUS SETTINGS screen. Here you can assign the Profibus address to be a value (in between 1 and 126). The default Profibus address is 7.

Section 4: Communication Specification

1. Ensure the pump and the PLC user interface are configured for the same address and confirm by pressing the green check mark at the top of the screen

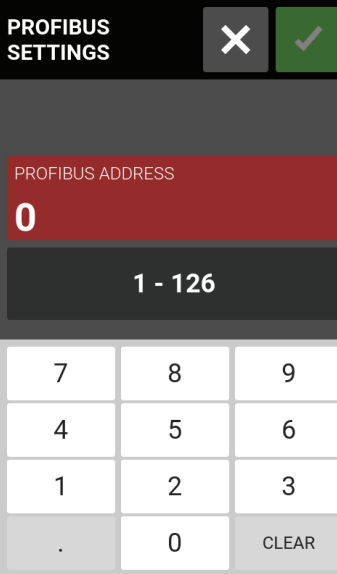

The screenshot shows a mobile application interface for configuring PROFIBUS settings. At the top, the title "PROFIBUS SETTINGS" is displayed in white on a black background. To the right of the title are two buttons: a grey button with a white "X" icon and a green button with a white checkmark icon. Below the title bar, the text "PROFIBUS ADDRESS" is shown in white on a dark red background. A large white "0" is displayed in the center of this red area. Below the red area, the text "1 - 126" is shown in white on a dark grey background. At the bottom of the screen is a numeric keypad with a grid of buttons. The buttons are arranged in four rows and three columns. The first row contains buttons for "7", "8", and "9". The second row contains buttons for "4", "5", and "6". The third row contains buttons for "1", "2", and "3". The fourth row contains buttons for ".", "0", and "CLEAR".

PROFIBUS DATA

The MASTERFLEX Pump Drive operates as a DP-V0 Slave.

GSD File: CPMP0FF8.GSD

ID Number: 0FF8 HEX

Default Slave Address: 7

Cyclic Input Data: 56 bytes

Cyclic Output Data: 28 bytes

Table 1 below lists the 56 bytes of cyclic input data, from pump to master.

Table 1

Cyclic Input (pump → master, 56 bytes)		
Data	Size in Bytes	Data Type
Pump Status	4	unsigned integer
Dispense Mode	1	unsigned integer
Tube Size	1	unsigned integer
Flow Units	1	unsigned integer
Padding (not used)	1	unsigned integer
Cumulative Volume	4	decimal floating-point
Remaining Dispense Volume	4	decimal floating-point
Remaining Dispense On Seconds	4	decimal floating-point
Remaining Dispense Off Seconds	4	decimal floating-point
Current Batch Count	4	unsigned integer
Total Batch Count	4	unsigned integer
Minimum Flow Rate	4	decimal floating-point
Current Flow Rate	4	decimal floating-point
Maximum Flow Rate	4	decimal floating-point
Remaining Dispense On Days	2	unsigned integer
Remaining Dispense On Hours	1	unsigned integer
Remaining Dispense On Minutes	1	unsigned integer
Remaining Dispense On Seconds	1	unsigned integer
Remaining Dispense On Tenths	1	unsigned integer
Remaining Dispense Off Days	2	unsigned integer
Remaining Dispense Off Hours	1	unsigned integer
Remaining Dispense Off Minutes	1	unsigned integer
Remaining Dispense Off Seconds	1	unsigned integer
Remaining Dispense Off Tenths	1	unsigned integer

Note:

Converting multi-byte data correctly will depend on the byte order configuration of the master.

The 4-byte decimal floating-point values are represented in IEEE-754 floating point format.

Pump Status, a 4-byte unsigned integer as shown in Table 1 above, indicates the pump's operation in separate bits. See Table 2 below for the description of each bit in Pump Status.

Table 2

Pump Status	
Status OK	bit 0
Pump Running	bit 1
Dispense On	bit 2
Tube Uncalibrated	bit 3
Head Open	bit 4
PROFIBUS Control	bit 5
Flow Direction CCW	bit 6
Remote Control	bit 7

Table 3 below lists the 28 bytes of cyclic output data, from master to pump.

Table 3

Cyclic Input (pump → master, 28 bytes)		
Data	Size in Bytes	Data Type
Pump Control	4	unsigned integer
Set Dispense Mode	1	unsigned integer
Set Tube Size	1	unsigned integer
Set Flow Units	1	unsigned integer
Padding (not used)	1	unsigned integer
Set Flow Rate	4	decimal floating-point
Set Dispense Volume	4	decimal floating-point
Set Dispense On Seconds	4	decimal floating-point
Set Dispense Off Seconds	4	decimal floating-point
Set Total Batch Count	4	unsigned integer

Pump Control, a 4-byte unsigned integer as shown in Table 3 above, controls the pump's operation in separate bits. See Table 4 below for the description of each bit in Pump Control.

Table 4

Pump Control	
Run (1) Pause (0)	bit 0
Stop and Reset Dispense (1 to 0)	bit 1
Toggle Remote/Local Control (1 to 0)	bit 2
Clear Cumulative Volume (1 to 0)	bit 3
Set Flow Direction CCW (1=CCW, 0=CW)	bit 6

A transition on bit 2 of Pump Control will toggle between local and remote control of the pump. For example, if the pump is in local mode, then a 1 to 0 transition will put the pump into PROFIBUS remote control mode. Only in this mode can any change in the cyclic output data influence the pump and be reflected in the cyclic input data.

Set Dispense Mode can be one of the following:

Continuous

Time Dispense

Volume Dispense

Set Tube Size and Set Flow Units are integer numbers, beginning with 1. The numbers correspond to the pump's local menu list in the front panel display interface. For example:
 tube size "13" from the local menu list corresponds to the value "1" for the Tube Size output value
 flow units "gal/hr" from the local menu list corresponds to the value "9" for the Flow Units output value



Set Flow Rate is a decimal floating-point number. Its value must be between the Minimum Flow Rate and Maximum Flow Rate values from the input data.

Set Dispense Volume is the amount of volume that will be dispensed in Volume Dispense Mode.

Set Dispense On Seconds is the amount of time the pump will dispense in Time Dispense Mode.

Set Dispense Off Seconds is used for both Time and Volume dispense modes. It sets the amount of time the pump will pause between dispenses.



SECTION 5: SERVICE & MAINTENANCE

	CAUTION: Replace the power cord only with one of the same type and rating.
	CAUTION: Unplug the pump drive's power cable from the mains power outlet when cleaning or performing maintenance on the drive.

FIRMWARE UPDATES



If the B/T is connected to the internet, updates can be downloaded directly onto the pump drive. **NOTE:** When new updates are available for your device, the update available  icon will be displayed at the top of the Settings Menu Screen.

To update B/T:

1. Tap **SETTINGS**  from any of the mode screens. The Settings Screen will be displayed.
2. **SCROLL**  through the Settings Screen pages to locate **DEVICE INFORMATION**.
3. Tap **DEVICE INFORMATION**. The Device Information Screen will be displayed.
4. Tap **CHECK FOR UPDATES** and follow the onscreen prompts.

If the B/T is not connected to the internet, updates must be downloaded onto a USB drive before installing onto the pump drive. Visit www.masterflex.com to download the latest updates for your device.



To install updates from a USB drive:

1. Insert the USB drive containing the updates into the pump drive's USB port.
2. Tap **SETTINGS**  from any of the mode screens. The Settings Screen will be displayed.
3. **SCROLL**  through the Settings Screen pages to locate **DEVICE INFORMATION**.
4. Tap **DEVICE INFORMATION**.
5. Tap **CHECK FOR UPDATES** and follow the onscreen prompts.

RESTORE FACTORY SETTINGS

NOTE: Factory reset will erase all settings, including custom programs.

To restore the pump to the original factory defaults:

1. Tap **SETTINGS**  from any of the mode screens. The Settings Screen will be displayed.
2. **SCROLL**  through the Settings Screen pages to locate **DEVICE INFORMATION**.
3. Tap **DEVICE INFORMATION**.
4. Tap **FACTORY RESET** and follow the onscreen prompts.

CLEANING THE PUMP DRIVE



CAUTION: Unplug the pump drive's power cable from the mains power outlet when cleaning or performing maintenance on the drive.

If required, the pump drive may be wiped clean using a soft cloth lightly moistened with either isopropyl or ethyl alcohol.

NOTE:

- Care should be taken with the pump drive's touchscreen to avoid scratching or otherwise damaging the surface. Do not wipe with dry or abrasive material.
- Do not operate the pump drive with water on the surface of the touchscreen.
- Any damage caused by improper cleaning will be the sole responsibility of the customer.

ACCESSORIES

B/T Accessories

To purchase accessories or for further information visit www.masterflex.com. The following accessories are available for the B/T Digital Pump Drive:

Description	Part Number
Footswitch with 6 ft (1.8 m) cable and 31-Pin male connector	07575-84
31-Pin male connector (no cable, connector only)	109736-CR
Cable assembly (31-Pin male connector and 25 ft (7.9 m) cable with stripped wire ends)	07575-80
FUSE,T6.3A, 5MM X 20MM	117197

REPLACEMENT PARTS

Description	Part Number
Rotor Assy	108024-CR
Spacer, Shoulder	109461-CR
Window	109467-CR
Door Assembly	109473-CR
Replacement Line Cord Assem 115V	109573-CR
Roller & Retaining Ring Kit BT	109852-CR
FUSE,T6.3A, 5MM X 20MM	117197
Cable and Switch	113333-CR

REPLACING ROLLERS

Follow these steps when replacing the rollers:

1. Using a retaining ring tool (Part Number 109852-CR), remove the retaining rings from the ends of the roller axles and slide the rollers off. Take care to avoid opening the retaining rings too wide.
2. Check to be sure that the wave washers are installed on the axles against the rotor plate.
3. Slide the new rollers, Replacement Roller Kit 07584-02, onto the axles, placing the ends with the flush bearing surface inward toward the rotor plate against the wave washers, and the etched ends with the recessed bearing surface outward toward the free ends of the roller axles.
4. Replace the retaining rings. You may have to push the rollers in to compress the wave washers to allow the retaining rings to engage the grooves in the axles.

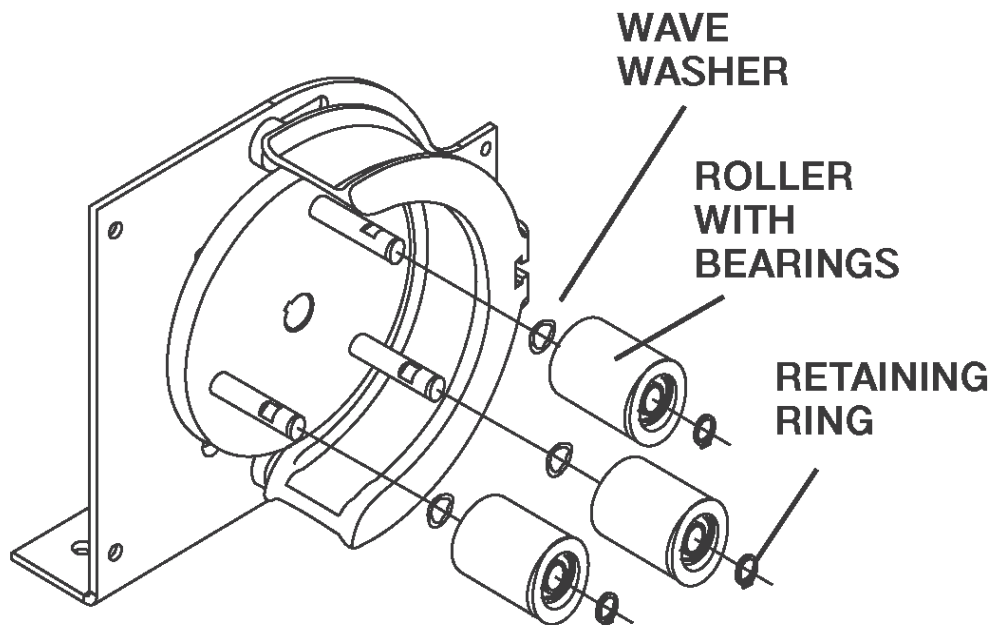

TUBING TYPES

Use Only Masterflex *PERFECTIONPOSITION* B/T precision tubing with MASTERFLEX pumps to ensure optimum performance.

Use of other tubing may void applicable warranties.

NOTE: Use Masterflex *PERFECTIONPOSITION* B/T Tubing. These pumps are designed to use *PERFECTIONPOSITION* B/T tubing sizes 87 and 91 only. The tubing sizes refer to the last two digits of the Masterflex *PERFECTIONPOSITION* B/T tubing model numbers.

Tubing Size

Characteristics	B/T 87	B/T 91
Inside Dia. in (mm)	0.5 (12.7)	0.75 (19.05)
Hose Barb Size in (mm)	1/2" (12.7)	3/4" (19.0)
Flow Range (with 321 rpm drive)	0.17-5.0 GPM (0.010-18.9 LPM)	0.37-11.1 GPM (1.40-42.0 LPM)
Nominal Flow Per Revolution	58.88 mL	130.84 mL
Maximum Vacuum	28.5 in Hg	28.5 in Hg
Maximum Pressure	35 PSI	30 PSI

All Masterflex *PERFECTIONPOSITION* B/T tubing formulations in sizes B/T 87 and B/T 91 can be used with this pump. Be sure tubing material matches application.



WARNING: Verify tubing material chemical compatibility prior to use. It is the sole responsibility of the user to determine suitability of this product for the application.

Tubing Type

Characteristics	B/T 87	B/T 91
Silicone - 10 ft. (3.0 m), Platinum Cured	96510-87	96510-91
Silicone - 10 ft. (3.0 m), Peroxide Cured	96400-87	96400-91
BioPharm Plus Silicone - 10 ft. (3.0 m), Platinum Cured	96445-87	96445-91
C-FLEX - 10 ft. (3.0 m)	06424-87	06424-91
Puri-Flex™ - 10 ft. (3.0 m)	96419-87	96419-91
Chem-Durance® BIO - 25 ft. (7.6 m)	06442-87	06442-91
PharMed® BPT - 25 ft. (7.6 m)	06508-87	06508-91
PharMed® BPT - 3 ft. (0.9 m)	95668-87	95668-91
PharmaPure® - 10 ft. (3.0 m)	06437-87	06437-91
NORPRENE® food - 25 ft. (7.6 m)	06402-87	06402-91

31-PIN ELECTRICAL CONNECTIONS



CAUTION: Power must be turned off before connecting the external analog control cable to prevent damage to the drive.

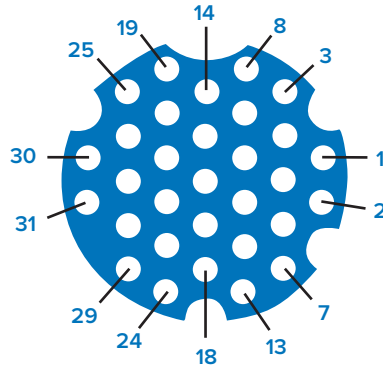

Contact Arrangements:

31-Pin No.	Description	31-Pin No.	Description
1	Speed Control Voltage Input (0–10 V)	13	Motor Running Relay Common
2	Speed Signal Voltage Output (0–10 V)	14	Remote Prime Input
3	Speed Control Current Input (0-20 mA)	15	Open Head Relay Output (N.O.)
4	Remote Start/Stop Input	16	General Alarm Ready Common
5	Speed Control Input Ground Reference	17	Not Used
6	Remote CW/CCW Input	18	Local/Remote Relay Common
7	Speed Signal Current Output (0-20 mA)	19	Open Head Relay Common
8	Remote Start/Stop, CW/CCW, Prime Grnd Ref.	20	General Alarm Relay Output (N.O.)
9	Speed Signal Output Ground Reference	21	Not Used
10	Tach Ground Reference	22	Local/RemoteRelay Output (N.O.)
11	Motor Running Relay Output (N.O.)	23–31	Not Used
12	Tach Output (Open Collector)	-	-

TROUBLESHOOTING

For further assistance, or for issues that cannot be resolved, see "[Technical Assistance](#)" on page 5-10.

Symptom	Cause	Remedy
Motor does not rotate. Display does not light.	No power.	1. Check that the power cord is securely plugged into the drive.
		2. Check that the power cord is plugged into the mains power outlet and that the power is switched on.
		3. Check the power cord for any visible signs of damage and replace if defective.
Pump does not rotate during analog operation. The display does not light up during analog operation.	Defective analog control or setting error.	1. Switch the pump drive off.
		2. Check that the 31-Pin connection cable is fully inserted into the drive's port.
		3. Switch on the pump drive.
		4. If the motor still does not rotate, select ANALOG INPUT from the Mode Selection Screen and/or the Settings Screen and verify that the settings are correct.
		5. For further information see " Analog Input Mode " on page 3-13.
Weak calibration strength displayed on the calibration strength bar.	Poor calibration volume and/or flow rate.	Calibration accuracy can be improved by using a larger calibration volume and/or altering the flow rate.
Touchscreen unresponsive.	Wearing thick latex gloves can make the screen less responsive.	Remove gloves before using the touchscreen. NOTE: Consult your company or laboratory safety guidelines before removing any personal protective equipment.

ERROR DEFINITIONS

Error #2: No Encoder Pulses

Description:	The drive's processor has not received expected encoder feedback.
Actions:	Drive will stop immediately. Verify load is correct and power cycle drive. If error persists see " Technical Assistance " on page 5-10.

Error #5: Communication Watchdog Timeout

Description:	Internal communications have exceeded allowable time limit.
Actions:	Drive will stop immediately. Power cycle the pump drive. If error persists see " Technical Assistance " on page 5-10.

Error #6: Pump Head Opened During Cal

Description:	The occlusion bed of the pump is no longer in its closed position, or an internal connection is loose or broken.
Actions:	Drive will stop immediately. Close pump head. If necessary power cycle the pump drive. If error persists see " Technical Assistance " on page 5-10.

Error #9: Over Speed

Description:	The drive has exceeded commanded speed value.
Actions:	Drive will stop immediately. Verify load is correct and power cycle the pump drive. If error persists see " Technical Assistance " on page 5-10.

SPECIFICATIONS

OUTPUT

Speed:	11 to 321 RPM
Torque Output, Max Continuous:	.4 HP x 63025 /321 RPM= 78.5 in-lbs 78.5 in-lbs x16= 1256.6 oz-in
Speed Regulation:	Line $\pm 0.1\%$ F.S. Load $\pm 0.1\%$ F.S. Drift $\pm 0.1\%$ F.S.
Display:	800 x 480 LCD w/ LED Backlight
Outputs:	Voltage speed output (0-10VDC @ 1 k Ω min) Current speed output (4-20 mA @ 0-600 Ω) Motor running relay (Closed when running, 1 A max @ 24 VDC) General alarm relay (Closed when error is displayed, 1 A @ 24 VDC) Open head relay (Closed when activated, 1 A @ 24 VDC) Tach output (110 – 3210 Hz, 50% Duty Cycle, 10 Hz per RPM)

INPUT

Supply Voltage Limits:	90 to 230 Vrms @ 50/60 Hz (Universal Input)
Max Current:	5.0 A @ 115 VAC; 3.1 A @ 230 VAC
Inputs:	Start/Stop, Prime, CW/CCW (Contact closure) Current input (0-20 mA @ 249 Ω ; ± 50 V common mode range) Voltage input (0-10 VDC @ 10 k Ω ; ± 50 V common mode range) RJ45 Ethernet USB, Type A (5 VDC @ 0.5 A)

CONSTRUCTION

Dimensions (L x W x H):	24.5" x 15.8" x 18.8" (622 mm x 401 mm x 478 mm)
Weight:	120 lbs. (54.4 kg)

Enclosure Rating:	IP66 per IEC 60529: Display Enclosure Main Power Enclosure Motor's Control Housing
--------------------------	---

ENVIRONMENT

Operating Temperature:	0 °C to 40 °C (32 °F to 104 °F)
Storage Temperature:	-25 °C to 65 °C (-13 °F to 149 °F)
Humidity (Non-Condensing):	10% to 90%
Altitude:	Less than 2000 m
Pollution Degree:	Pollution Degree 3 (Indoor use, sheltered location)
Chemical Resistance:	Exposed material is stainless steel, aluminum, thermoplastic

COMPLIANCE

Drive	UL 61010-1, UL 61010-2-081 US/CAN For CE mark: EN61010-1, Low Voltage Directive ETSI EN 301 489-1, EMC Directive EN50581, RoHS Directive
Pump Head	EN809, Machinery Directive

TECHNICAL ASSISTANCE

If you have any questions about the use of this product contact the manufacturer or authorized seller.

PRODUCT RETURN

Like all pumps, the B/T pump drive contains components that will wear over a period of time. To limit charges and delays contact the seller or manufacturer for authorization and shipping instructions before returning the product, either within or outside of the warranty period. When returning the product please state the reason for the return. For your protection, pack the product carefully and insure it against possible damage or loss. Any damages resulting from improper packaging are your responsibility.

WARRANTY

Visit www.masterflex.com for warranty information.

DISPOSAL

Please retain packaging materials until the product warranty ends. Afterwards please discard of any packaging materials in an environmentally friendly manner and according to local regulations.

Once the useful life of the product has ended, please ensure proper disposal according to local laws. Plastic and electronic components should be disposed of at a recycling facility. Please refer to local regulations regarding proper disposal.

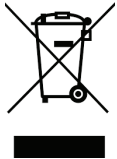

MASTERFLEX[®]

US & Canada only

Toll Free 1-800-MASTERFLEX | 1-800-637-3739

Outside US & Canada

1-847-381-7050

***EN809 manufactured by:**

Masterflex LLC.

28092 W Commercial Avenue, Barrington, IL 60010

masterflex.tech @ avantorsciences.com

www.avantorsciences.com/masterflex